



# SECTION 2 FOOT & CHECK VALVES YARD HYDRANTS



PRODUCT LINE	PAGE
Check Valves	
Brass, Bronze, Stainless Steel .....	1-4
Clayton Mark .....	7-9
Plastic .....	15
Simmons .....	11-12
Foot Valves	
Brass, Bronze, Stainless Steel .....	5-6
Cast Iron, Steel Suction Strainer .....	16
Clayton Mark .....	10
Plastic .....	15
Simmons .....	13
Yard Hydrants .....	17-20





# Check Valves - Brass, Bronze

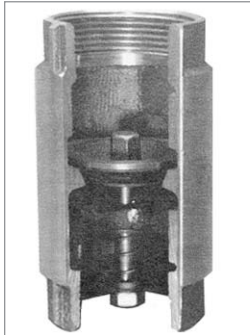

## CHECK VALVE Features:

- Cast Brass, bronze, lead free brass or stainless steel body & poppet.
- Buna-N o-ring (Viton on stainless steel).
- Stainless steel springs, washers, locknuts.
- Delrin poppet stem guide.
- 200 psi WOG working pressure.
- 300 lb. max hang weight (down pull) tension.
- Individually cartoned.
- Imported.

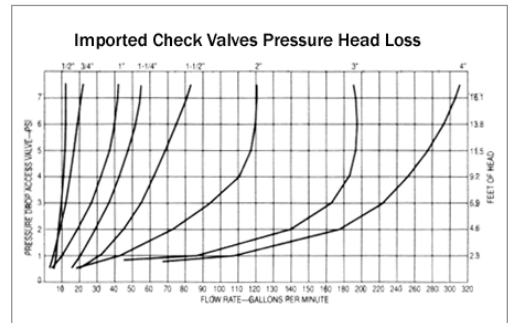

CV-BS Series

## CV-BS Series BRASS Check Valves

- Rough body finish.

Part Number	Size	Ctn Qty	List Price
CV50BS	1/2"	100	\$ 11.01
CV75BS	3/4"	80	14.46
CV100BS	1"	60	20.00
CV125BS	1 1/4"	40	31.79
CV150BS	1 1/2"	30	35.54
CV200BS	2"	20	70.11



CVXLD Series

## CVXLD Series BRASS Check Valves

- Rough body finish.
- Extra long at discharge end.

Part Number	Size	Ctn Qty	List Price
CVXLD100BS	1" x 1"	60	\$ 38.75
CVXLD125BS	1 1/4" x 1 1/4"	40	45.54



CV-B Series

## CV-B Series BRONZE Check Valves

- Machined body finish.

Part Number	Size	Ctn Qty	List Price
CV50B	1/2"	100	\$ 13.25
CV75B	3/4"	80	19.36
CV100B	1"	60	27.32
CV125B	1 1/4"	40	38.39
CV150B	1 1/2"	30	51.96
CV200B	2"	20	89.11
CV300B	3"	6	308.04
CV400B	4"	3	676.71



CVNL-BS Series

## CVNL-BS Series LEAD FREE BRASS Check Valves

- Rough body finish.

Part Number	Size	Ctn Qty	List Price
CVNL50BS	1/2"	100	\$ 13.35
CVNL75BS	3/4"	80	17.75
CVNL100BS	1"	60	26.17
CVNL125BS	1 1/4"	40	41.31
CVNL150BS	1 1/2"	30	47.63
CVNL200BS	2"	20	93.71
CVNL300BS	3"	6	273.21
CVNL400BS	4"	3	668.98



TM

In the United States: Phone (800) 776-2266 Fax (800) 729-3299  
In Canada: Phone (866) 503-5523 Fax (888) 562-2095

www.americangranby.com

4/17/12

# Check Valves - Brass, Bronze, Stainless Steel

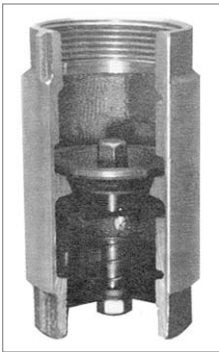

## IMPORTED CHECK VALVE Features:

- Cast Brass, bronze, lead free brass or stainless steel body & poppet.
- Buna-N o-ring (Viton on stainless steel).
- Stainless steel springs, washers, locknuts.
- Delrin poppet stem guide.
- 200 psi WOG working pressure.
- 300 lb. maximum hang weight (down pull) tension.
- Individually cartoned.
- Imported.

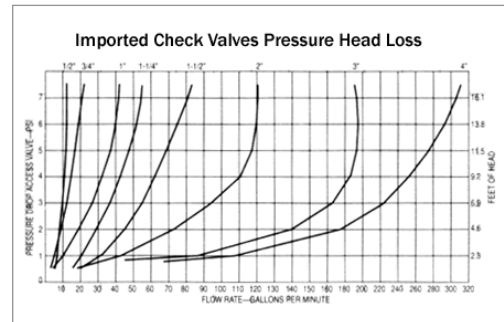

SSCV Series

## SSCV Series STAINLESS STEEL Check Valves

- 304 cast stainless steel casting, springs, washers, lock nut.
- Viton o-ring

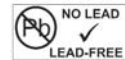

Part Number	Size	Ctn Qty	List Price
SSCV50	1/2"	100	\$ 24.65
SSCV75	3/4"	80	32.92
SSCV100	1"	60	41.47
SSCV125	1 1/4"	40	58.03
SSCV150	1 1/2"	30	77.53
SSCV200	2"	20	125.80
SSCV300	3"	6	545.16
SSCV400	4"	3	1048.57
SSCV1025	1" fpt x 1 1/4" mpt	60	62.50



CVMR-BS Series

## CVMR-BS Series BRASS Submersible Check Valves

- Rough body finish.
- FPT x MPT

Part Number	Size (FPT X MPT)	Ctn Qty	List Price
CVMR100BS	1" x 1"	60	\$ 30.89



CVMXL Series

## CVMXL Series BRASS Submersible Check Valves

- Rough body finish.
- Extra long body.

Part Number	Size (M X F)	Ctn Qty	List Price
CVMXL100BS	1" x 1"	60	\$ 26.61
CVMXL125BS	1 1/4" x 1 1/4"	40	34.82



CVM-B Series

## CVM-B Series BRONZE Submersible Check Valves

- Machined body finish.
- FPT x MPT

Part Number	Size (FPT X MPT)	Ctn Qty	List Price
CVM100B	1" x 1"	60	\$ 35.89
CVM125B	1" x 1 1/4"	60	33.14
CVM1252B	1 1/4" x 1 1/4"	40	51.25



# Check Valves - Brass, Bronze

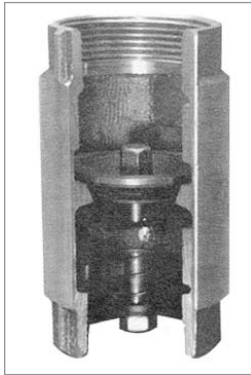

## CHECK VALVE Features:

- Cast Brass, bronze, lead free brass or stainless steel body & poppet.
- Buna-N o-ring (Viton on stainless steel).
- Stainless steel springs, washers, locknuts.
- Delrin poppet stem guide.
- 200 psi WOG working pressure.
- 300 lb. maximum hang weight (down pull) tension.
- Individually cartoned.
- Imported

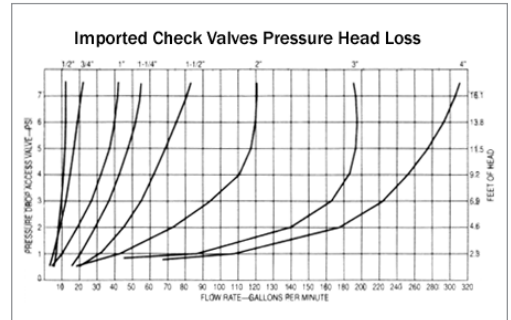

CVMNL-BS Series

## CVMNL-BS Series LEAD FREE BRASS Submersible Check Valves

- Rough body finish.
- FPT x MPT

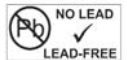

Part Number	Size (FPT X MPT)	Ctn Qty	List Price
CVMNL1252BS	1 1/4" x 1 1/4"	40	\$ 51.61



CVT-1B Series

## CVT-1B Series BRONZE Single Tap Check Valves

- Machined body finish.
- 1/8" inlet tap.

Part Number	Size	Ctn Qty	List Price
CVT1001B	1"	60	\$ 34.43
CVT1251B	1 1/4"	40	47.36



CVRT-2BS Series

## CVRT-2BS Series BRASS Double Tap Check Valves

- Rough body finish.
- One 1/8" inlet tap.
- One 1/4" outlet tap.

Part Number	Size	Ctn Qty	List Price
CVRT1002BS	1"	60	\$ 31.25
CVRT1252BS	1 1/4"	40	43.96

# Check Valves - Brass, Bronze

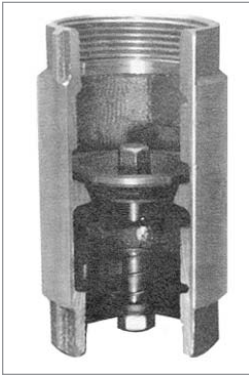

## CHECK VALVE Features:

- Cast Brass, bronze, lead free brass or stainless steel body & poppet.
- Buna-N o-ring (Viton on stainless steel).
- Stainless steel springs, washers, locknuts.
- Delrin poppet stem guide.
- 200 psi WOG working pressure.
- 300 lb. maximum hang weight (down pull) tension.
- Individually cartoned.
- Imported.

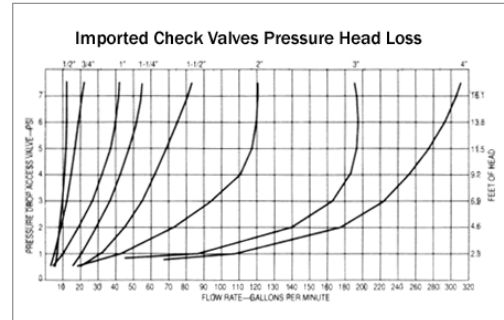

CVT-2B Series

## CVT-2B Series BRONZE Double Tap Check Valves

- Machined body finish.
- One 1/8" inlet tap.
- One 1/4" outlet tap.

Part Number	Size	Ctn Qty	List Price
CVT1002B	1"	60	\$ 33.57
CVT1252B	1 1/4"	40	45.00
CVT1502B	1 1/2"	30	56.96
CVT2002B	2"	20	112.50



CVT-3B Series

## CVT-3B Series BRONZE Control Center Check Valves

- Machined body finish.
- One 1/8" inlet tap.
- One 1/8" and one 1/4" outlet taps.

Part Number	Size	Ctn Qty	List Price
CVT1003B	1"	60	32.68
CVT1253B	1 1/4"	40	38.04



CVC-B Series

## CVC-B Series BRONZE Control Center Check Valves

- Machined body finish.
- One 1/8" inlet tap.
- One 1/8" and two 1/4" outlet taps.

Part Number	Size	Ctn Qty	List Price
CVC100B	1"	60	34.46
CVC125B	1 1/4"	40	46.23



# Foot Valves - Brass, Bronze



### FOOT VALVE Features:

- Cast Brass, bronze, lead free brass or stainless steel body & poppet.
- Buna-N o-ring (Viton on stainless steel).
- Stainless steel springs, washers, locknuts and strainers.
- 200 psi WOG working pressure.
- Individually cartoned.
- Imported.



FVR-BS Series

### FVR-BS Series BRASS Foot Valves

- Rough body finish.

Part Number	Size	Enters Pipe	Ctn Qty	List Price
FVR50BS	1/2"	1 1/4"	100	\$ 10.37
FVR75BS	3/4"	1 1/2"	80	14.11
FVR100BS	1"	2"	60	19.92
FVR125BS	1 1/4"	2 1/2"	40	26.22
FVR150BS	1 1/2"	3"	30	31.61
FVR200BS	2"	3 1/2"	20	56.00



FV-B Series

### FV-B Series BRONZE Foot Valves

- Machined body finish.

Part Number	Size	Enters Pipe	Ctn Qty	List Price
FV50B	1/2"	1 1/4"	100	\$ 13.25
FV75B	3/4"	1 1/2"	80	15.38
FV100B	1"	2"	60	23.39
FV125B	1 1/4"	2 1/2"	40	30.89
FV1251B	1 1/4"	2"	50	31.07
FV150B	1 1/2"	3"	30	41.50
FV200B	2"	3 1/2"	20	71.36
FV300B	3"	5"	8	261.61
FV400B	4"	-	4	470.83



FV-BS Series

### FV-B Series BRONZE Dual Purpose Foot Valves

- Machined body finish.

Part Number	Size	Enters Pipe	Ctn Qty	List Price
FV100125B	1" FPT x 1 1/4"MPT	2"	60	\$ 28.21

# Foot Valves - Brass, Bronze, Stainless Steel



## FOOT VALVE Features:

- Cast Brass, bronze, lead free brass or stainless steel body & poppet.
- Buna-N o-ring (Viton on stainless steel).
- Stainless steel springs, washers, locknuts and strainers.
- 200 psi WOG working pressure.
- Individually cartoned.
- Imported.



FVNL-BS Series

## FVNL Series LEAD FREE BRASS Foot Valves

- Rough body finish.

Part Number	Size	Enters Pipe	Ctn Qty	List Price
FVNL50BS	1/2"	1 1/4"	100	\$ 10.47
FVNL75BS	3/4"	1 1/2"	80	16.96
FVNL100BS	1"	2"	60	24.61
FVNL125BS	1 1/4"	2 1/2"	40	33.13
FVNL150BS	1 1/2"	3"	30	42.88
FVNL200BS	2"	3 1/2"	20	77.86
FVNL300BS	3"	5"	8	232.50
FVNL400BS	4"	-	4	487.68

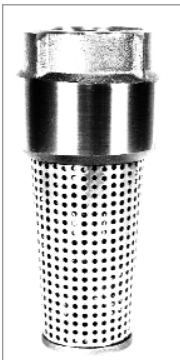

SSFV Series

## SSFV Series STAINLESS STEEL Foot Valve Features:

- 304 Stainless steel casting, spring, washer, locknut, strainer
- Viton o-ring

Part Number	Size	Enters Pipe	Ctn Qty	List Price
SSFV50	1/2"	1 1/4"	100	\$ 16.79
SSFV75	3/4"	1 1/2"	80	32.19
SSFV100	1"	2"	60	41.79
SSFV125	1 1/4"	2 1/2"	40	55.34
SSFV150	1 1/2"	3"	30	58.07
SSFV200	2"	3 1/2"	20	144.70
SSFV300	3"	5"	8	464.41
SSFV400	4"	-	4	1038.73



FVSC & CVSP Series

## FVSC, CVSP Series Stainless Screen, Endcap, Screw, Spring

- Spring replacement for all imported check and foot valves

Screen/Cap/Screw Part Number	Spring Part Number	Size	FVSC List Price	CVSP List Price
FVSC50	CVSP50	1/2"	\$ 6.36	\$ 2.68
FVSC75	CVSP75	3/4"	6.71	2.68
FVSC100	CVSP100	1"	7.36	2.68
FVSC125	CVSP125	1 1/4"	8.86	3.36
FVSC150	CVSP150	1 1/2"	9.11	3.36
FVSC200	CVSP200	2"	12.04	3.75
FVSC300	CVSP300	3"	43.75	4.43
FVSC400	CVSP400	4"	62.50	4.79



# Check Valves - Clayton Mark

- FOR USE IN WATER WELL SYSTEMS



## 6300 Bronze Check Valve Features:

- The Buna-N rubber coated poppet seals under high & low pressure applications.
- Delrin Stem Guide to improve flow.
- Self locking nut is vibration proof.
- Stainless steel spring.
- 400 PSI rated (WOG).
- Maximum operating temperature 140°F.
- Hex ends for easy installation.

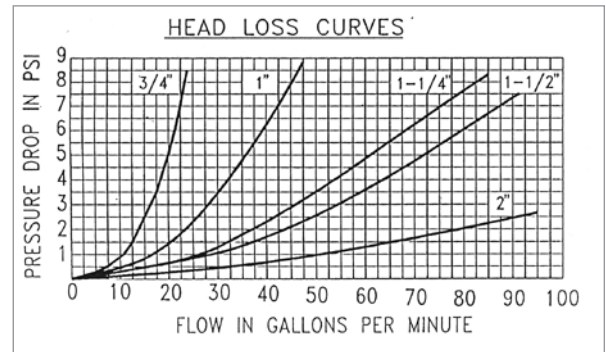

Part Number	Size	Enters Casing	Ctn Qty	List Price
6300-3/4	3/4"	1-1/2"	48	\$ 36.96
6300-1	1"	2"	35	38.60
6300-11/4	1-1/4"	2-1/2"	24	52.93
6300-11/2	1-1/2"	3"	20	73.96
6300-2	2"	3-1/2"	12	119.64



## 5300 Bronze Check Valve Features:

- Highly finished bronze body with a flat seated poppet to withstand increased water pressure for a continuous period of time.
- 400 PSI (W.O.G.)
- Maximum operating temperature 140°F.
- Corrosion resistant, stainless steel poppet core on 5300-1/2".
- Bronze poppet on 5300-2 1/2, 3 and 4".
- Not suitable for all types of oil and gas.
- Heavy hex ends for easy installation.

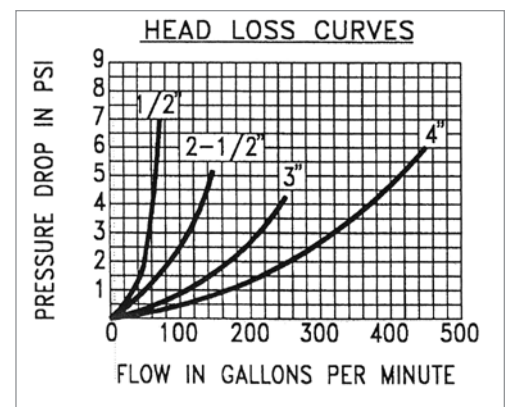

Part Number	Size	Enters Casing	Ctn Qty	List Price
5300-1/2	1/2"	1-1/2"	48	\$ 36.21
5300-21/2	2-1/2"	5"	1	510.57
5300-3	3"	6"	1	615.32
5300-4	4"	8"	1	745.18

# Check Valves - Clayton Mark



- FOR USE IN WATER WELL SYSTEMS



**CLAYTON MARK**®



## 6300-1 Bronze One Hole Control Center

- 1/8"-27NPS tapping on inlet side for snifter valve.
- NOTE: 2-1/2 inch size has the 5300 poppet design.

Part Number	Size	Ctn Qty	List Price
63001-1	1"	35	\$ 52.12
63001-11/4	1-1/4"	30	<b>73.39</b>
63001-11/2	1-1/2"	20	81.29
63001-2	2"	12	136.04

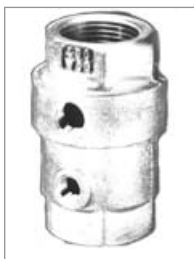

## 6300-2 Bronze Two Hole Control Center

- 1/8"-27NPS tapping on inlet side for snifter valve.
- 1/4"-18NPS tapping on outlet side for pressure switch.
- NOTE: 4 inch has the 5300 poppet design.

Part Number	Size	Ctn Qty	List Price
63002-1	1"	35	\$ 54.65
63002-11/4	1-1/4"	30	68.79
63002-11/2	1-1/2"	20	88.75
63002-2	2"	12	138.04



## 63000218 Bronze Two Hole Control Center

- Two 1/4"-18NPS tappings on outlet side.

Part Number	Size	Ctn Qty	List Price
6300218-1	1"	35	\$ 55.79
6300218-11/4	1-1/4"	30	68.59



## 6300-3 Bronze Three Hole Control Center

- 1/8"-27NPS tapping on inlet side for snifter valve.
- 1/4"-18NPS tapping on outlet side for pressure switch.
- 1/4"-18NPS tapping on outlet side for pressure gauge.

Part Number	Size	Ctn Qty	List Price
63003-1	1"	35	\$ 52.96
63003-11/4	1-1/4"	30	68.57



# Check Valves - Clayton Mark

- FOR USE IN WATER WELL SYSTEMS



## 6300-4 Bronze Four Hole Control Center

- 1/8"-27NPS tapping on inlet side for snifter valve.
- 1/4"-18NPS tapping on outlet side for pressure gauge.
- 1/4"-18NPS tapping on outlet side for pressure switch.
- 1/8" tapping on outlet side for drain(1/8" brass plug furnished).

Part Number	Size	Ctn Qty	List Price
63004-1	1"	35	\$ 52.96
63004-11/4	1-1/4"	30	68.57



## 6302 Bronze Submersible Check Valves

- Fits directly on pump discharge.

Part Number	Size (mpt x fpt)	Ctn Qty	List Price
6302-11/4x1	1-1/4" x 1"	30	\$ 36.75
6302-11/4x11/4	1-1/4" x 1-1/4"	30	51.59
6302-2x2	2" x 2"	12	148.57
6302-3x3	3" x 3"	1	607.23
6302-4x4	4" x 4"	1	1056.82



## 461 BRONZE CHECK VALVES

- Non corrosive brass check valve designed to be set in 2" casing.
- Uses a tapered rubber packer to seal in the well bore.

Part Number	Size	Ctn Qty	List Price
8663A	2"	24	\$ 49.29



## 479 BRONZE BREMER CHECK VALVES

- Non corrosive bronze with tapered seat and poppet with Perma-Kleen facing for positive seal.
- Uses a tapered rubber packer to seal in the well bore.

Part Number	Size	Ctn Qty	List Price
8669A	2"	12	\$ 59.82
8034C	2" Rubber Check Packer		11.17

# Foot Valves - Clayton Mark



- FOR USE IN WATER WELL SYSTEMS



## 6340 SERIES Bronze Foot Valves

- 400 PSI rating. (W.O.G.)
- Tapered ABS strainer.
- Corrosion resistant, stainless steel core with exclusive cup shape.
- Maximum operating temperature is 140°F.
- Jam proof delrin stem guide.

Part Number	Size	Enters Casing	Ctn Qty	List Price
6340-3/4	3/4"	1-1/2"	48	\$ 32.29
6340-1	1"	2"	35	35.89
6340-11/4	1-1/4"	2"	30	43.29
6340-11/2	1-1/2"	3"	20	69.89
6340-2	2"	3-1/2"	12	110.89



## 5340 SERIES Bronze Foot Valves

- No. 8 perforated brass screen strainer.
- 400 PSI rating.
- Corrosion resistant, stainless steel core with exclusive cup shape.
- Maximum operating temperature is 140°F.

Part Number	Size	Enters Casing	Ctn Qty	List Price
5340-3/4	3/4"	1 1/4"	48	\$ 35.54
5340-1	1"	1 1/2"	35	39.51
5340-11/4	1 1/4"	2"	24	47.73
5340-11/2	1 1/2"	2 1/2"	20	87.32
5340-2	2"	3 1/2"	12	123.89



## 5330 Bronze Foot Valves

- All bronze.
- No 8 perforated strainer.
- Heavy hex end.

Part Number	Size	Enters Casing	Ctn Qty	List Price
5330-21/2	2-1/2"	5"	1	\$ 408.54
5330-3	3"	6"	1	<b>625.56</b>
5330-4	4"	6"	1	890.00



# Check Valves - Simmons

- FOR USE IN WATER WELL SYSTEMS
- \* Silicon bronze components contain less than 0.05% ( 1/20 of 1%) lead.

**Simmons**

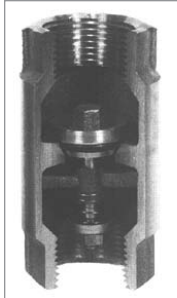

## LF5100 Series Silicon Bronze LEAD FREE\* check valves

- Silicon bronze cast body and poppet..
- Buna-N o-ring, stainless steel spring, washer and lock nut.
- 400 PSI (WOG working pressure).
- Made in U.S.A.



Part Number	Simmons	Size	Ctn Qty	List Price
LF5100-1/2	501SB	1/2"	50	\$ 48.30
LF5100-3/4	502SB	3/4"	50	48.89
LF5100-1	503SB	1"	50	51.48
LF5100-1LT	513SB	1" w/ Longer Threads	50	53.70
LF5100-11/4	504SB	1 1/4"	36	70.56
LF5100-11/2	505SB	1 1/2"	24	98.61
LF5100-2	506SB	2"	16	159.53
LF5100-21/2	507SB	2 1/2"	1	680.77
LF5100-3	508SB	3"	1	820.44
LF5100-4	509SB	4"	1	1426.30
LF5100-5	510SB	5"	1	1918.06
LF5100-6	511SB	6"	1	2606.64



## LF5100A Series Silicon Bronze LEAD FREE\* check valves

- Same as 5100 Series plus:
- 1/8" single inlet tapping.
- Made in U.S.A.



Part Number	Simmons	Size	Ctn Qty	List Price
LF5100A3/4	521SB	3/4"	50	\$ 55.74
LF5100A1	522SB	1"	50	65.66
LF5100A11/4	523SB	1 1/4"	36	87.60
LF5100A11/2	524SB	1 1/2"	24	108.36
LF5100A2	525SB	2"	16	171.54
LF5100A21/2	526SB	2 1/2"	1	809.14
LF5100A3	527SB	3"	1	1180.35
LF5100A4	528SB	4"	1	1560.38

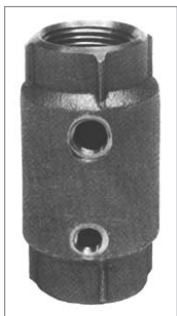

## LF5100B Series Silicon Bronze LEAD FREE\* Check Valves

- Same as 5100 Series plus:
- With 1/8" Inlet Tapping, 1/4" Outlet Tappings.
- Made in U.S.A.



Part Number	Simmons	Size	Ctn Qty	List Price
LF5100B3/4	541SB	3/4"	50	\$ 58.71
LF5100B1	542SB	1"	50	70.50
LF5100B11/4	543SB	1 1/4"	36	86.74
LF5100B11/2	544SB	1 1/2"	24	112.35
LF5100B2	545SB	2"	16	174.14
LF5100B21/2	546SB	2 1/2"	1	850.76
LF5100B3	547SB	3"	1	1201.28
LF5100B4	548SB	4"	1	1570.89

# Check Valves - Simmons



- FOR USE IN WATER WELL SYSTEMS
- \* Silicon bronze components contain less than 0.05% ( 1/20 of 1%) lead.

**Simmons**



## LF5100C Series Silicon Bronze LEAD FREE\* Control Center

- Made in U.S.A.

Part Number	Simmons	Size	Inlet Tap	Outlet Tap	Ctn Qty	List Price
LF5100C1	601SB	1"	1/8" (1)	1/4" (2)	1	\$ 70.65
LF5100C11/4	602SB	1 1/4"	1/8" (1)	1/4" (2)	1	91.49
LF5100C11/2	603SB	1 1/2"	1/8" (1)	1/4" (2)	1	116.56
LF5100C2	604SB	2"	1/8" (1)	1/4" (2)	1	208.10
LF5101C1	606SB	1"	-	1/4" (2)	1	70.65
LF5101C11/4	607SB	1 1/4"	-	1/4" (2)	1	91.49



## LF5100D Series Silicon Bronze LEAD FREE\* submersible Check Valves

- Installation between pump and column pipe.
- Made in U.S.A.



Part Number	Simmons	Size (FxM)	Ctn Qty	List Price
LF5100D1x1	616SB	1"x1"	1	\$ 52.23
LF5100D1x1LT	610SB	1"x1" w/ longer threads	1	56.13
LF5100D1x11/4	617SB	1"x1 1/4"	1	50.47
LF5100D11/4x11/4	618SB	1 1/4"x1 1/4"	1	67.06



## LF6700 Series DUCTILE IRON LEAD FREE\* Check Valve

- Ductile iron body.
- Silicon bronze poppet and stainless steel spring and nut.
- Non toxic paint.
- For use with large submersible pumps.
- Made in U.S.A.



Part Number	Simmons	Size	Pipe	Ctn Qty	List Price
LF6700-1	653SB	1"	1 7/8"	1	\$ 29.75
LF6700-11/4	654SB	1 1/4"	2 5/16"	1	47.79
LF6700-11/2	655SB	1 1/2"	2 5/8"	1	59.45
LF6700-2	680SB	2"	3 1/4"	1	93.23
LF6700-3	670SB	3"	4 1/8"	1	352.12
LF6700-4	671SB	4"	5 5/8"	1	550.62
LF6700-6	672SB	6"	7 5/8"	1	998.98



## LF7000 Series Silicone Bronze LEAD FREE\* Pressure Regulator Valve

- Silicon bronze cast body.
- Adjustable bronze cylinder control
- For deep well pumps.
- Positive o-ring seat.
- PT series with pressure line tapping.
- Made in U.S.A.



Part Number	Simmons	Size	Line Tap	Ctn Qty	List Price
LF7000-3/4	730SB	3/4 x 3/4 x 3/4"	-	1	\$ 81.63
LF7000PT1	731SB	1 x 1 x 1"	1/8"	1	92.89
LF7000PT3/4	729SB	3/4 x 3/4 x 3/4"	1/4"	1	81.63



# Foot Valves - Simmons

- FOR USE IN WATER WELL SYSTEMS
- \* Silicon bronze components contain less than 0.05% ( 1/20 of 1%) lead.



## 5000S Series Silicone Bronze Foot Valve Features:

- Silicon bronze cast body and poppet.
- Stainless steel perforated screen.
- Specify LFN5000S 1-1/4 special valve for 2" ID casing.
- 400 PSI working pressure
- Made in U.S.A.



Part Number	Simmons	Size	Ctn Qty	List Price
LF5000S3/4	452SB	3/4"	60	\$ 43.06
LF5000S1	453SB	1"	60	47.84
LFN5000S11/4	404SB	1 1/4"	36	56.13
LF5000S11/4	455SB	1 1/4"	36	57.72
LFS5000S11/4	454SB	1 1/4"	36	52.27
LF5000S11/2	456SB	1 1/2"	24	93.20
LF5000S2	457SB	2"	12	147.84
LF5000S21/2	458SB	2 1/2"	1	491.62
LF5000S3	459SB	3"	1	675.52
LF5000S4	460SB	4"	1	1123.98



## LF4000 Series SILICON BRONZE Dual Purpose Foot Valve Features:

- Same as LF5000S Series plus:
- Dual purpose foot valve. Threaded inside and outside.
- Made in U.S.A.



Part Number	Simmons	Size (F x M)	Ctn Qty	List Price
LF4000-3/4 x 1	456SB	3/4" x 1"	1	\$ 51.36
LF4000-1 x 1 1/4	466SB	1" x 1 1/4"	1	53.68
LF4000-1 1/4 x 1 1/2	467SB	1 1/4" x 1 1/2"	1	63.89



## LF50S Series SILICON BRONZE Suction Strainer Features:

- Same as LF5000S Series plus:
- Full flow suction strainer.
- Made in U.S.A.



Part Number	Simmons	Size	Diameter	Length	Ctn Qty	List Price
LF50S3/4	490SB	3/4"	1 3/8"	3 3/4"	1	\$ 43.06
LF50S1	491SB	1"	1 3/4"	4 3/4"	1	49.86
LF50S11/4	492SB	1 1/4"	2 5/16"	5 1/4"	1	66.41
LF50S11/2	493SB	1 1/2"	2 1/2"	6 5/16"	1	93.42
LF50S2	494SB	2"	3 1/8"	7 3/16"	1	143.23
LF50S21/2	495SB	2-1/2"	4"	9 3/8"	1	344.25
LF50S3	496SB	3"	4 5/8"	9 1/2"	1	458.51
LF50S4	497SB	4"	6"	13 7/8"	1	710.76

# Check Valves - LF5100 Series Pressure, Head Loss



Applies to all Simmons LF5100 Series check valves on previous pages

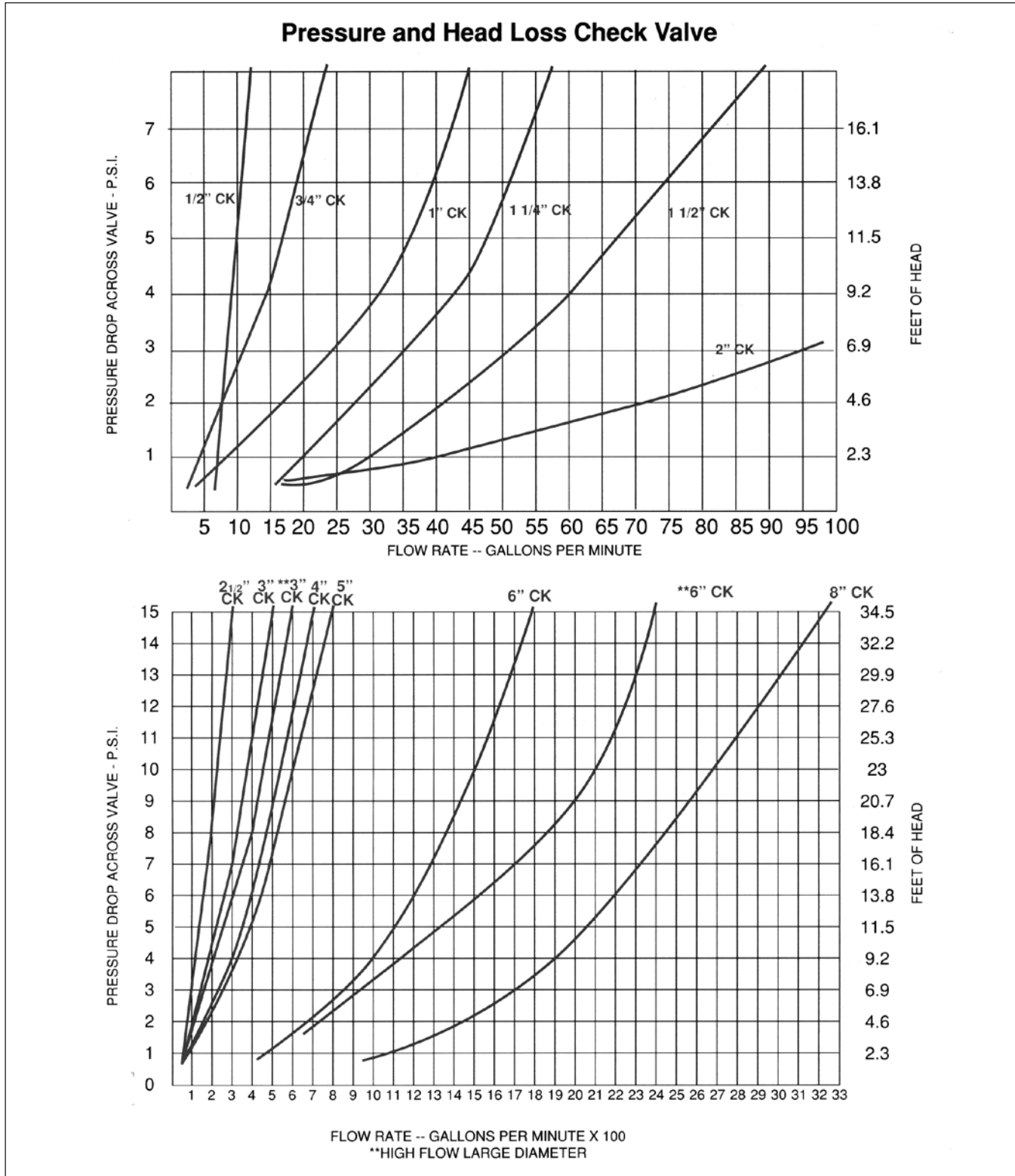



# Foot & Check - Plastic



FV441

## HARVARD Four in One Plastic Foot Valve

- Positive sealing - spring loaded valve poppet closes against a smooth tapered seat.
- Corrosion resistant nylon body and internals.
- Self cleaning design for continuous positive sealing.
- Large screen designed to assure smooth water passage and better suction.
- Tapered screen eliminates pipe joint hang-ups during installation.
- Fits four pipe sizes., 3/4" through 1 1/2"



Part Number	Size	Ctn Qty	List Price
FV441	3/4" through 1 1/2"	100	\$ 16.61



FV Series



LC Series



FV SN Series

## Brady Plastic Foot & Check Valve Features:

- "Nose Cone" diffuser reduces friction.
- 50% greater water flow.
- Acetal copolymer construction.
- Non-electrolytic, non-corrosive.
- Spring loaded, 316 stainless steel
- BUNA-N seal
- Pressure max: 175 psi
- Temperature max: 180 F
- LC check valve, FPT x FPT



Part Number	Size	Ctn Qty	List Price
<b>Brady Foot Valve - Spring Loaded</b>			
FV75	3/4"	12	\$ 20.98
FV100	1"	30	24.52
FV125	1-1/4"	32	35.24
FV150	1-1/2"	21	42.36
<b>Brady Check Valve- Spring Loaded</b>			
LC75	3/4"	24	17.90
LC100	1"	24	20.98
LC125	1-1/4"	24	31.48
LC150	1-1/2"	12	37.69
<b>Brady Foot Valve Strainer</b>			
FV75SN	3/4"	50	2.15
FV100SN	1"	50	2.38
FV125SN	1-1/4"	50	3.43
FV150SN	1-1/2"	50	3.34

# Foot Valves - Cast Iron, Steel Suction Strainer



5400 Series

## Cast Iron Foot Valve Features:

- Available in painted red or galvanized finish.
- Includes neoprene flapper check to maintain prime.
- For use in drainage on construction sites, irrigation projects, pumping from ponds or streams.



**CLAYTON MARK®**

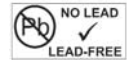

Part Number	Valve Size	Flapper OD Size	PAINTED List Price	GALVANIZED List Price
<b>PAINTED RED</b>	<b>GALVANIZED</b>			
5400-1	1"	2 1/2"	\$ 26.82	
5400-11/4	1-1/4"	2 3/4"	40.95	
5400-11/2	1-1/2"	3 1/4"	<b>49.18</b>	
5400-2	2"	4 1/4"	<b>52.61</b>	
5400-21/2	5400-21/2G	2-1/2"	<b>89.80</b>	<b>94.29</b>
5400-3	5400-3G	3"	<b>93.99</b>	<b>150.48</b>
5400-4		4"	<b>190.00</b>	
5400-5		5"	345.24	
5400-6	5400-6G	6"	<b>480.13</b>	<b>511.19</b>
5400-8		8"	<b>912.24</b>	



## 5400 Series Complete Repair Kits

- Single kit to repair both painted and galvanized versions.
- Replacement strainers available in galvanized finish only.
- Contains all components required to replace inner flapper assembly.
- Includes valve weight, neoprene flapper, sealing washer, bolt, washer and nut.



Valve Size	LEATHER FLAPPER ONLY		NEOPRENE FLAPPER ONLY		COMPLETE REPAIR KIT (w/ neoprene flapper)	
	Part No.	List Price	Part No.	List Price	Part No.	List Price
1"	5400-1LR	\$ 5.81	8367A	\$ 4.91		
1 1/4"	5400-11/4LR	6.81			CIRK125	28.08
1 1/2"	5400-11/2LR	7.39	8367C	5.23	CIRK150	32.01
2"	5400-2LR	10.62	8367D	7.39	CIRK200	40.57
2 1/2"	5400-21/2LR	11.25	8367E	7.92	CIRK250	53.23
3"	5400-3LR	15.85	8367F	18.74	CIRK300	65.88
4"	5400-4LR	39.19	8367G	27.25	CIRK400	88.31
5"	5400-5LR	52.23	-	-	CIRK500	113.04
6"	5400-6LR	64.26	8367J	44.94	CIRK600	187.56
8"	5400-8LR	100.59	8367K	61.78	CIRK800	271.58

## FLAT STEEL ROUND HOLE STRAINERS

- General purpose strainer, zinc plated to prevent corrosion.
- 16 gauge steel.

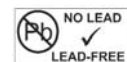

Part Number	Pipe Size	Hole Size	Height	Diameter	Ctn Qty	List Price
8800B	2"	.375"	4"	6"	20	\$ 28.51



# Yard Hydrants - Frost Proof



5451 Series

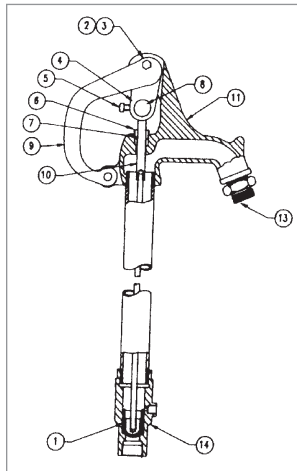

HVB75



RBHE



RBHT

## 5451 Series Frost Proof Yard Hydrant Features:



CLAYTON MARK<sup>®</sup>



- Fully frost proof, shut-off valve below frost line.
- Heavy cast iron head with 3/4" brass discharge connection and bucket hook.
- Heavy, galvanized steel, corrosion resistant, 1" stand-pipe.
- Galvanized carbon steel connecting rod. Brass operating rod.
- Long lasting Buna-N rubber plunger with solid brass core.
- Integral valve seat cast into **BRONZE** valve body. 3/4" FPT connection with double bypass bottom valve for superior flow, less risk of debris blockage.
- 1/8" FPT drain hole.
- Rated to 80 PSI, adjustable. See page 2.18 for adjustment procedure.
- Packed securely in individual heavy weight carton.
- Independent lab tested.
- CE certified.

Part Number	Bury Depth	Overall Length	Weight (Pounds)	List Price
54511	1	42"	12.4	\$ 129.32
54512	2	54"	15.2	138.65
54513	3	66"	17.8	147.99
54514	4	78"	21.0	157.32
54515	5	90"	22.3	166.65
54516	6	102"	26.2	177.32
54518	8	126"	30.7	195.98

## Materials of Construction

#	Item	Material	#	Item	Material
1	Plunger	Buna-N/360 brass	9	Handle	Cast iron
2	Fulcrum Bolt	Steel - Zinc plated	10	Clevis Rod	360 brass
3	Fulcrum Nut	Steel - Zinc plated	11	Head	Cast Iron
4	Links	Steel - Zinc plated	13	Hose Adpt 3/4"	360 brass
5	Set Screw	Steel - Zinc plated	14	Bottom valve	Bronze 81-3-7-9
6	Packing Nut	360 brass		Stand Pipe	Steel - galvanized 1"
7	Packing	Teflon filled graphite			
8	Connector	Brass			

Part Number	Size	# Barbs	Ctn/Case Qty	List Price
<b>Vacuum Breaker</b>				
HVB75	3/4" Meets ASSE 1011 specifications		20/200	\$ 7.54
<b>Cast Bronze Hydrant Elbow (INSxMIP)</b>				
RBHE3/4	3/4" x 3/4"	5	10/100	12.40
RBHE1X3/4	1" x 3/4"	5	10/100	16.39
RBHE1	1" x 1"	5	10/100	16.75
RBHE11/4	1 1/4" x 1 1/4"	5	5/50	30.86
<b>Cast Bronze Extra Long Hydrant Elbow (INS x MIP)</b>				
XLRBHE1	1" x 1"	8	10/100	21.61
XLRBHE1X3/4	1" x 3/4"	10	10/100	20.83
<b>Cast Bronze Hydrant Tee (INS x MIP)</b>				
RBHT3/4	3/4" x 3/4"	4	10/100	16.00
RBHT1x3/4	1" x 3/4"	6	10/100	21.25
RBHT1	1" x 1"	4	10/100	21.61



In the United States: Phone (800) 776-2266 Fax (800) 729-3299  
 In Canada: Phone (866) 503-5523 Fax (888) 562-2095

www.americangranby.com

12/13/11

# Yard Hydrants - Replacement Parts



**CLAYTON MARK**®

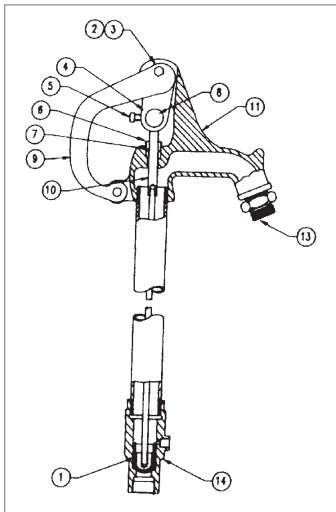

3/4" 5451 Hydrant Flow Rates

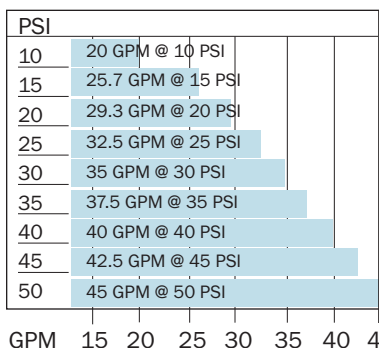

## 5451 Series Hydrant Replacement Parts

Part Number	Item Number	Description	List Price
YRK1		Repair Kit (Items 1-8)	\$ 17.33
9175B	1	Plunger - rubber	6.37
9023B	2	Fulcrum Bolt - steel	0.36
9023C	3	Nut - steel	0.27
9023D	4	Links (set of 2) - steel	2.38
9023E	5	Set Screw square head - steel	0.47
9023A	6	Packing Nut - brass	<b>3.18</b>
29609G	7	Packing - graphite (2 - 1 old, 1 new style)	<b>4.03</b>
9023G	8	Connector - brass	<b>5.79</b>
2506K	9	Handle - painted cast iron	10.14
2222AHNS	10	Clevis Rod - brass NEW STYLE (double bypass)	11.77
2500K	11	Head only - painted cast iron	34.19
382914	13	Hose Adapter - brass	7.31
381504	14	Valve Body - bronze	45.00
2575K		Complete Head Assembly (Items 2-13)	53.59

### STEEL ROD (use with double bypass valve 5451 Series)

TA7100099NS	54511 Rod (32 5/8" old or 32.4" new)	7.49
TA7100100NS	54512 Rod (44 5/8" old or 44.4" new)	10.62
TA7100101NS	54513 Rod (56 5/8" old or 56.4" new)	13.67
TA7100102NS	54514 Rod (68 5/8" old or 68.4" new)	16.51
TA7100103NS	54515 Rod (80 5/8" old or 80.4" new)	19.39
TA7100104NS	54516 Rod (92 5/8" old or 92.4" new)	22.28
TA7100105NS	54518 Rod (116 5/8" old or 116.4" new)	24.45

**NOTE:** All 5451 Series Hydrants are preset at factory. There should be no need for any adjustment on initial installation. Adjust only if water does not shut off or hydrant does not operate properly.

## 5451 HYDRANT ADJUSTMENT PROCEDURE

- Turn water supply OFF.
- Open hydrant to relieve pressure.
- Loosen set screw. (Item 1)
- Push brass rod down as far as it will go by hand to be sure the plunger is touching the seat.
- Open handle (Item 2) approximately 30° from closed position.
- Tighten set screw snugly.
- Turn water supply ON.
- Operate hydrant and make sure the hydrant is shutting off properly and flowing properly.
- If hydrant still does not shut off, repeat steps 1 through 8.**
- Flow water through hydrant and then close completely to check for proper drainage by:
  - listening for water draining down pipe or
  - putting your hand over the hose connection to feel for a vacuum.
 If hydrant does not drain, see step 11.
- To clear drain hole blockage, close off hydrant spout by using hose cap or by attaching and kinking a hose. Open and close hydrant to allow water pressure to clear blockage. Repeat step 10 to verify proper drainage. If hydrant still does not drain, repeat steps 1 through 10 to fully uncover drain hole.

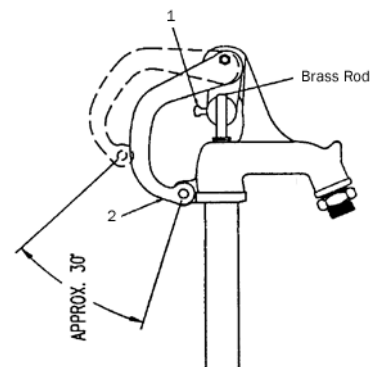

**CAUTION:** Do not try to make the shutoff adjustment in one attempt or you may overadjust and cause damage to the plunger and rods. For this reason adjust in multiple small increments.



# Yard Hydrants - Frost Proof



## Deluxe Frost Proof Yard Hydrant Features:

- FROST-PROOF - Shut-off valve operates below the frost line.
- Pistol type handle eliminates pinching.
- Can be padlocked.
- Wheel handle controls water flow at rate desired.
- Solid brass rod will not rust or cut into packing.
- Water in standpipe drains out when hydrant is off.
- Brass nozzle threaded for standard 3/4" hose coupling.
- Inner parts removable without digging.
- 80 PSI maximum pressure.
- Individually boxed.



**CONTAINS LEAD - Not for sale in California. Call for lead free hydrant quote.**

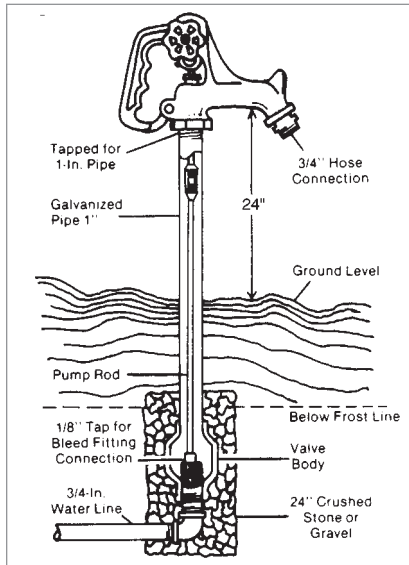
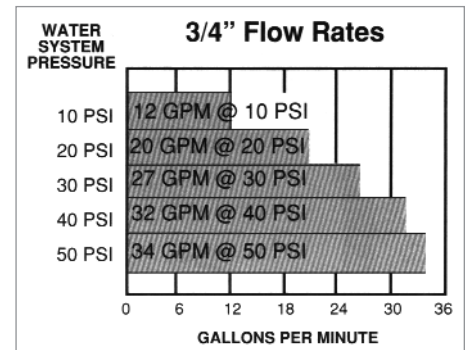

Part Number	Bury Depth	Pipe Length	Overall Length	Ctn Qty	List Price
H800	1 ft	33"	39 1/2"	1	\$ 148.57
H801	1 1/2 ft	41"	47 1/2"	1	152.65
H802	2 ft	47"	53 1/2"	1	165.04
H803	3 ft	59"	65 1/2"	1	165.71
H804	4 ft	71"	77 1/2"	1	177.40
H805	5 ft	83"	89 1/2"	1	189.13
H806	6 ft	95"	101 1/2"	1	203.88
H807	7 ft	107"	113 1/2"	1	215.56
H808	8 ft	119"	125 1/2"	1	230.77



HVB75



RBHE



RBHT

Part Number	Size	# Barbs	Ctn/Case Qty	List Price
<b>Vacuum Breaker</b>				
HVB75	3/4" Meets ASSE 1011 specifications		20/200	\$ 7.54
<b>Cast Bronze Hydrant Elbow (INSxMIP)</b>				
RBHE3/4	3/4" x 3/4"	5	10/100	12.40
RBHE1X3/4	1" x 3/4"	5	10/100	16.39
RBHE1	1" x 1"	5	10/100	16.75
RBHE11/4	1 1/4" x 1 1/4"	5	5/50	30.86
<b>Cast Bronze Extra Long Hydrant Elbow (INS x MIP)</b>				
XLRBHE1	1" x 1"	8	10/100	21.61
XLRBHE1X3/4	1" x 3/4"	10	10/100	20.83
<b>Cast Bronze Hydrant Tee (INS x MIP)</b>				
RBHT3/4	3/4" x 3/4"	4	10/100	16.00
RBHT1x3/4	1" x 3/4"	6	10/100	21.25
RBHT1	1" x 1"	4	10/100	21.61

# Yard Hydrants - Replacement Parts



## Replacement Parts For H800 Series Hydrants

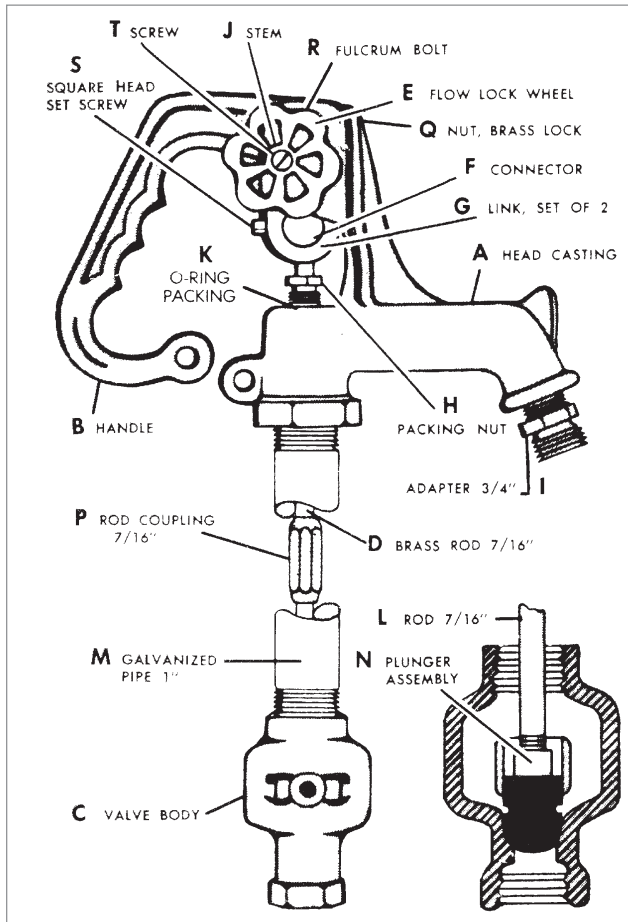

Part Number	Reference Number	Name of Part	List Price
8820	A	Head	\$ 52.74
8821	B	Handle	17.14
8822	C	Valve Body	60.34
8823	D	Brass Extension	11.66
8824	E	Hand Wheel	2.98
8825 *	F	Connector - brass	28.95
8826 *	G	Links(pair) - brass	15.35
8827 *	H	Packing Nut - brass	10.17
8828	I	Brass Hose Adapter	10.94
8829	J	Hydrant Stem	4.16
8839 *	K	O-Ring Packing	2.87
8814-0	L	7/16" Pump Rod for H800	25.07
8814-1		7/16" Pump Rod for H801	31.45
8814-2		7/16" Pump Rod for H802	37.50
8814-3		7/16" Pump Rod for H803	47.89
8814-4		7/16" Pump Rod for H804	58.02
8814-5		7/16" Pump Rod for H805	68.20
8814-6		7/16" Pump Rod for H806	78.21
8814-7		7/16" Pump Rod for H807	88.39
8814-8		7/16" Pump Rod for H808	98.41
8815-0	M	Pipe Casing for H800	28.77
8815-1		Pipe Casing for H801	37.93
8815-2		Pipe Casing for H802	45.16
8815-3		Pipe Casing for H803	57.21
8815-4		Pipe Casing for H804	69.22
8815-5		Pipe Casing for H805	81.22
8833 *	N	Plunger - Buna-N	12.44
8834	P	Rod Coupling	4.70
8301 *	Q	Lock Nut - stainless steel	0.91
8836 *	R	Fulcrum Bolt - stainless steel	3.72
8837 *	S	Set Screw - stainless steel	1.81
8610	T	Screw for Wheel	1.47
840		Head, Complete	85.86
850		*Included in Parts Kit	41.77