

WATER FILTRATION & DISINFECTION



Automatic Flush Valve	39
Filter Cartridges	5-7
Filter Cartridges - Big Bubba	10
Filter Cartridges - Pentair	15-21
Filter Housings, Kits & Accessories	1-4
Filter Housings - Big Bubba	9
Filter Housings - Pentair	13-14
Filter Kits & Accessories - Pentair	22
Filtration Systems - Pentek	23
Harmsco™ Filter Systems	25-30
Iron Out	24
LMI Uni-Dose Electronic Metering Pumps	51-52
Pulsafeeder Chemical Feed Pumps	45-50
R/O & Chemical Containment Systems	11-12
Saddle Tap Valve and Kit	24
Ultraviolet Disinfection Systems	41-43
Vu-Flow Filters & Sand Separators	31-39





Harvard Series Housing Features:

- Available in slim and large diameter styles.
- 10" and 20" lengths. Blue and Clear sumps.
- All housings have a pressure relief button.
- 3/4" inlet/outlets on slimline, 1" inlet/outlets on large diameter.
- Maximum temperature rating to 125°F and pressure rating to 125 psi.
- Recommended maximum operating pressure 85 psi for slim style and 90 psi for large diameter.
- Filter housings are bulk packed. Cartridges available separately.



Double o-ring on standard slimline

Standard Housing Features:

- Standard Housings manufactured from NSF listed, FDA grade 100% polypropylene (polycarbonate for clear).
- Patented double EPDM o-ring seals on slimline assures long term seal. Single o-ring seal on large diameter.



Housing with Stainless Steel Inserts Features:

- Manufactured from NSF listed, FDA grade 100% polypropylene, polycarbonate or tinted AS for clear.
- 10" and 20" length. Blue or clear/tinted blue sumps.
- **Stainless Steel** threaded inserts on inlets and outlets.
- Single EPDM o-ring seals assures long term seal.



Single o-ring on SS inserts



Part No.	Style	Sump	Head	Inlet/Outlet	Length	Ctn Qty	List Price
SLIM STYLE Housing only with pressure relief for 2 1/2" OD cartridges							
HH75BSLBP	Slim	Blue	Black	3/4"	10"	12	\$ 34.82
HH75BSLBP20	Slim	Blue	Black	3/4"	20"	8	80.18
HH75CSLWP	Slim	Clear	Black	3/4"	10"	12	43.98
LARGE DIAMETER STYLE Housing only with pressure relief for 4 1/2" O.D. cartridges							
HHLD10BP	Lg. Diam	Blue	Black	1"	10"	6	103.62
HHLD10BP20	Lg. Diam	Blue	Black	1"	20"	6	148.21
HHLD10CP	Lg. Diam	Clear	Black	1"	10"	6	148.85
SLIM STYLE Housing only with <u>SS</u> inserts, pressure relief for 2 1/2" OD cartridges							
HH75BSLBPSS	Slim	Blue	Black	3/4" SS insert	10"	12	\$ 49.00
HH75CSLWPSS	Slim	Clear Tint	Black	3/4" SS insert	10"	12	61.71
LARGE DIAMETER STYLE Housing only with <u>SS</u> inserts, pressure relief for 4 1/2" O.D. cartridges							
HHLD10BPSS	Lg. Diam	Blue	Black	1" SS insert	10"	6	119.64
HHLD10CPSS	Lg. Diam	Clear	Black	1" SS insert	10"	6	192.35
HHLD10BPSS20	Lg. Diam	Blue	Black	1" SS insert	20"	6	170.75
HHLD10CPSS20	Lg. Diam	Clear	Black	1" SS insert	20"	6	269.75

NEW

WARNING: Prevent Freezing. Never exceed recommended maximum operating pressures. Use proper pressure reducing valves to protect filter housings from excessive pressure surges.

DO NOT over tighten fittings used to install filter housing. Over tightening will result in cracking the housing threads and will void all limited warranties. Only PTFE thread seal tape OR non-PTFE based thread seal paste approved for plastic threads should be used to seal filter housing threads - NOT BOTH.

Harvard Filter Kits and Accessories



Standard Filter Housing Kit Features:

- Slim and Large diameter styles.
- Complete with full size white, powder coated steel mounting bracket, stainless steel screws, sump removal wrench, extra o-ring. (2 o-rings on slim, 1 o-ring on large diameter.)
- Individually cartoned with label.
- Custom kits available. Call Customer Service for quotations.



Part Number	Style	Sump	Head	Inlet/Outlet	Length	Case Qty	List Price
HFHP75BSLBP	Slim	Blue	Black	3/4"	10"	10	\$ 54.65
HFHP75BSLBP20	Slim	Blue	Black	3/4"	20"	10	80.36
HFHP75CSLWP	Slim	Clear	Black	3/4"	10"	10	58.88
HFHPLD10BP	Large Dia	Blue	Black	1"	10"	6	134.06
HFHPLD10BP20	Large Dia	Blue	Black	1"	20"	4	200.47
HFHPLD10CP	Large Dia	Clear	Black	1"	10"	6	187.73

Stainless Steel Insert Filter Housing Kit Features:

- Slim and Large diameter styles **with stainless steel** threaded inserts.
- Complete with full size white, powder coated steel mounting bracket, stainless steel screws, sump removal wrench and extra o-ring.
- Individually cartoned with label.
- Custom kits available. Call Customer Service for quotations.



NEW

Part Number	Style	Sump	Head	Inlet/Outlet	Length	Case Qty	List Price
HFHP75BSLBPSS	Slim	Blue	Black	3/4" SS	10"	10	\$ 56.96
HFHP75CSLWPSS	Slim	Clear	Black	3/4" SS	10"	10	75.63
HFHPLD10BPSS	Large Dia	Blue	Black	1" SS	10"	6	139.00
HFHPLD10CPSS	Large Dia	Clear	Black	1" SS	10"	6	220.35
HFHPLD10BPSS20	Large Dia	Blue	Black	1" SS	20"	6	203.00
HFHPLD10CPSS20	Large Dia	Clear	Black	1" SS	20"	6	317.14



HS-BA Series

Part Number	Fits Style	Material	Color	Ctn Qty	List Price
Mounting Brackets for Harvard Series Filter Housings					
Includes stainless steel head and wall mounting screws					
HS10BA	Slim (L)	Powder coated steel	White		\$ 11.99
HS25BA	Large Diam. (L)	Powder coated steel	White		58.07



HW Series



HOR Series

Wrenches for Harvard Series Filter Housing sump removal

HWSL	Slim	Polypropylene	White		3.70
HWLD	Large Diam.	Polypropylene	White		9.99

O-rings for Harvard Series Filter Housings

HOR4	Slim	EPDM			2.15
HOR5	Large Diam.	EPDM			4.39
HOR4SS	Slim w/ SS Insert	EPDM			2.15
HOR5SS	Large Diam w/SS Insert	EPDM			4.21

Harvard VIH Filter Housing, Kit and Accy

Harvard Series Valve-In-Head with By-Pass and 304 Stainless Steel Insert Housing Features:

- Three piece design includes ring nut for quick and easy assembly.
- Valve-in-head design offers shut off and by-pass modes. No need for separate shut-off valves to isolate the filter.
- Automatic pressure venting.
- 3/4" 304 stainless steel inserts reinforce threaded I/O ports.
- Clear, tinted sump.
- Accepts 2 1/2" x 10" filter cartridges.
- Made from food grade materials.
- Maximum temperature rating to 100°F and pressure rating to 125 psi.
- Kit contains: By-pass housing, steel U mounting bracket, mounting screws, wrench and extra o-ring.
- ANSI/NSF 42 listed.
- ANSI/NSF 372 Low Lead certified and listed.



NEW



MATERIAL SPECIFICATIONS	
Head	Reinforced polypropylene
Clear Sump	SAN
Valve	Acetal
ORing	EPDM
SS FPT inserts	304 SS



Part No.	Style	Sump	Head	Inlet/Outlet	Ctn Qty	List Price
By-Pass VIH Housing ONLY with SS inserts						
HH75VCPSS	By-Pass	Blue Tint	Black/Blue	3/4" SS insert	12	\$ 102.32
By-Pass VIH Housing KIT with SS inserts						
HFHP75VCPSS	By-Pass Filter with SS inserts - KIT				1	131.96
HS35BA	U Mounting Bracket for HH75VCPSS				1	13.39
HWVCPSS	Wrench for HH75VCPSS				125	6.96
HOR6SS	O-Ring for HH75VCPSS				250	6.43





EH Series



EH Series Economy Housing Features:

- Manufactured from NSF listed, FDA grade 100% polypropylene.
- Available in slim, standard and large diameter styles, 10" and 20" lengths.
- Opaque and clear sumps with EPDM o-ring seals.
- 3/8" - 3/4" inlet/outlets.
- All housings have a pressure relief button.
- Slim and Standard rated for temperature to 125°F, pressures to 125 psi.
- Filter housings are bulk packed. Cartridges available separately.

DO NOT over tighten fittings used to install filter housing. Over tightening will result in cracking the housing threads and will void all limited warranties. Only PTFE thread seal tape OR non-PTFE based thread seal paste approved for plastic threads should be used to seal filter housing threads - NOT BOTH.

Part No.	Style	Sump	Head	Inlet/Outlet	Length	Ctn Qty	List Price
SLIM STYLE Housings with pressure relief for 2 1/2" OD cartridges							
EH38BSLBP	Slim	Blue	Black	3/8"	10"	12	\$ 68.46
EH50BSLBP	Slim	Blue	Black	1/2"	10"	12	62.61
EH75BSLBP	Slim	Blue	Black	3/4"	10"	12	42.01
Valve-in-Head STANDARD STYLE Housings for 2 1/2" OD cartridges							
PFH75VC	Standard VIH*	Clear	Blue	3/4"	10"	12	153.82
STANDARD STYLE Housings with pressure relief for 2 1/2" OD cartridges							
EH75BP	Standard	Blue	Black	3/4"	10"	12	77.30

* Pentek



EFHP75VCP



Filter Housing Kit Features:

- Slim, VIH, Standard and Large diameter styles.
- Complete with mounting bracket (with stainless steel screws) and sump removal wrench.
- Individually cartoned with label.
- Custom kits available. Call Customer Service for quotations.

Part Number	Style	Sump	Inlet/Outlet	Length	Bracket	Case Qty	List Price
EFHP75VCP	Standard VIH*	Clear	3/4"	10"	YES	4	190.15
EFHP75BP	Standard	Blue	3/4"	10"	YES	4	106.96
EFHP75VP	Std VIH w/SS Inserts	White	3/4"	10"	YES	6	206.94

* Pentek

Economy Filter Accessories



ES-BA Series



EW Series



EOR Series



EIC100



Part Number	Fits Style	Material	Color	Ctn Qty	List Price
-------------	------------	----------	-------	---------	------------

Mounting Brackets for EH Series Filter Housings

Includes stainless steel head and wall mounting screws

ES10BA	EH Slim (L)	Aluminum	White		\$ 12.69
ES15BA	EH Valve in Head (U)	Aluminum	--		20.21
ES20BA	EH Standard (L)	Aluminum	White		28.22
ES25BA	EH Large Diam. (L)	Aluminum	---		100.45

Wrenches for EH Series Filter Housing sump removal

EWSL	Slim	Polypropylene	White		6.35
EWSTND	Standard	Polypropylene	White		6.13
EWLD	Large Diam.	Polypropylene	Black		15.36

O-rings for EH PFH Series Filter Housings

EOR4	Slim	EPDM			9.69
PFOR75	VIH (PFH75VC)	EPDM			14.49
EOR8	Standard	EPDM			5.25
EOR5	Large Diam.	EPDM			9.41

Inline Ice Maker Carbon Filter Features:

- NSF listed.
- Granular activated carbon medium.
- Removes chlorine, taste and odor from water
- Ideal for refrigerator ice makers, water dispensers and coffee makers.
- Furnished with or without 1/4" fittings.

Part Number	OD	Length	Fits Pipes	Pipe Ftgs	Ctn Qty	List Price
EIC100	2"	10"	1/4" FPT	NO	25	\$ 21.80
EIC100JG	2"	10"	1/4" plastic or copper tubing	1/4" John Guest	25	30.19



EFP Series



ANSI / NSF
STANDARD 42
COMPONENT
CERTIFIED



EFP Series Melt Blown Polypropylene Filter Cartridge Features:

- Melt blown polypropylene for purity and chemical compatibility.
- Ideal for aggressive chemicals and general sediment filtration when depth filtration is required.
- Max Flow rate 2-8 gpm based on micron.
- Contains no binders, agents, solvents, antistatic materials or wetting agents.
- Meets FDA requirements for food and beverage contact.
- No leachables or extractables to contaminate.
- No surface binders to reduce flow & increase change-out frequency.
- Rated for temperatures up to 140° F
- Shrink wrapped for purity.

Part Number	Micron	O.D.	Length	Ctn Qty	List Price
-------------	--------	------	--------	---------	------------

MELT BLOWN POLYPROPYLENE Filter cartridges: SLIM & STANDARD style housings

EFP1	1	2 1/2"	9 7/8"	48	\$ 13.66
EFP5	5	2 1/2"	9 7/8"	48	7.60
EFP20	20	2 1/2"	9 7/8"	48	8.47
EFP50	50	2 1/2"	9 7/8"	48	12.63

EFP1-20	1	2 1/2"	20"	24	27.04
EFP5-20	5	2 1/2"	20"	24	16.93
EFP20-20	20	2 1/2"	20"	24	15.51
EFP50-20	50	2 1/2"	20"	24	24.69

MELT BLOWN POLYPROPYLENE Filter cartridges: LARGE DIAMETER style housings

EFPBB1	1	4 1/2"	9 3/4"	24	57.55
EFPBB5	5	4 1/2"	9 3/4"	24	48.54
EFPBB20	20	4 1/2"	9 3/4"	24	48.54
EFPBB50	50	4 1/2"	9 3/4"	24	78.20

EFPBB1-20	1	4 1/2"	20"	12	126.75
EFPBB5-20	5	4 1/2"	20"	12	88.57
EFPBB20-20	20	4 1/2"	20"	12	92.12
EFPBB50-20	50	4 1/2"	20"	12	152.69



EFP_G Series



EFP-G Series Grooved Melt Blown Polypropylene Filter Cartridge Features:

- Grooved cartridges for increased surface area and greater dirt handling capacity.
- Melt blown polypropylene.
- Maximum temperatures 140° F
- Maximum pressure: 40 psid
- Recommended change out 30 psid.
- Maximum flow rate 2-8 gpm based on micron.
- Shrink wrapped for purity.
- Fits slim and standard style housings.

Part Number	Micron	OD	Length	Ctn Qty	List Price
EFP5G	5	2 1/2"	9 3/4"	48	\$ 10.58
EFP20G	20	2 1/2"	9 3/4"	48	10.57

Economy Filter Cartridges



EFWP Series

EFW Series Wound Filter Cartridge Features:

- Excellent depth filtration.
- FDA grade polypropylene fibers.
- Polypropylene center tubes.
- For temperatures to 140 F.
- Individually wrapped.



Part Number	Medium	Type of Construct	Micron	O.D.	Length	Ctn Qty	List Price
WOUND POLYPROPYLENE Filter cartridges for SLIM and STANDARD style housings							
EFWP1	Polypropylene	Wound	1	2 1/2"	9 7/8"	25	\$ 23.61
EFWP5	Polypropylene	Wound	5	2 1/2"	9 7/8"	25	13.05
EFWP20	Polypropylene	Wound	20	2 1/2"	9 7/8"	25	11.08
EFWP50	Polypropylene	Wound	50	2 1/2"	9 7/8"	25	11.05
EFWP1-20	Polypropylene	Wound	1	2 1/2"	20"	25	38.61
EFWP5-20	Polypropylene	Wound	5	2 1/2"	20"	25	37.12
EFWP20-20	Polypropylene	Wound	20	2 1/2"	20"	25	23.86
EFWP50-20	Polypropylene	Wound	50	2 1/2"	20"	15	40.62

WOUND POLYPROPYLENE Filter cartridges for LARGE DIAMETER style housings

EFWPBB1	Polypropylene	Wound	1	4 1/2"	9 3/4"	8	\$ 71.76
EFWPBB5	Polypropylene	Wound	5	4 1/2"	9 3/4"	8	44.85
EFWPBB20	Polypropylene	Wound	20	4 1/2"	9 3/4"	8	62.66
EFWPBB50	Polypropylene	Wound	50	4 1/2"	9 3/4"	8	66.15
EFWPBB1-20	Polypropylene	Wound	1	4 1/2"	20"	4	121.32
EFWPBB5-20	Polypropylene	Wound	5	4 1/2"	20"	4	81.78
EFWPBB20-20	Polypropylene	Wound	20	4 1/2"	20"	4	110.75
EFWPBB50-20	Polypropylene	Wound	50	4 1/2"	20"	4	114.34



EFGAC Series

EFGAC Series Granulated Activated Carbon Filter Cartridge Features:

- For removal of taste, odor, organic chemicals and chlorine.
- 5 micron



Part Number	Fits Housing Style	O.D.	Length	Ctn Qty	List Price
EFGAC10	Slim, Standard	2 1/2"	9 3/4"	24	\$ 24.40
EFGAC20	Slim, Standard	2 1/2"	20"	24	58.57
EFGACBB	Large Diameter	4 1/2"	9 3/4"	8	74.18
EFGACBB20	Large Diameter	4 1/2"	20"	4	124.00



EFSP Series



EFSP Series Pleated Filter Cartridge Features:

- Pleated cartridges provide increased surface area, lower pressure drop and longer service life than other cartridges.
- Cellulose-free, 100% synthetic media is washable and reusable, 5 micron and up, to reduce filter costs.
- Contains no binders or additives to breakdown which may cause foaming and filter degradation.
- Color coded end caps 2 3/4" OD.
- Individually wrapped for purity.

Specifications:

Maximum temperature	140° F
Minimum temperature	40° F
Maximum pressure	40 psid
Recommended change out	25 psid
Filter Media (1 & 5 micron)	Polypropylene
Filter Media (20 & 50 micron)	Polyester
Material - center tube	Polypropylene
Material - end caps	Molded Polyurethane
ID	1 1/6"

Part Number	Micron	End Cap Color	O.D.	Length	Ctn Qty	List Price
PLEATED Filter cartridges for STANDARD style housings						
EFSP1	1	Tan	2 3/4"	9 3/4"	50	\$ 40.86
EFSP5	5	White	2 3/4"	9 3/4"	50	19.38
EFSP20	20	Blue	2 3/4"	9 3/4"	50	15.37
EFSP50	50	Yellow	2 3/4"	9 3/4"	50	15.37
EFSP1-20	1	Tan	2 3/4"	20"	25	89.21
EFSP5-20	5	White	2 3/4"	20"	25	65.53
EFSP20-20	20	Blue	2 3/4"	20"	25	34.63
EFSP50-20	50	Yellow	2 3/4"	20"	25	60.57
PLEATED Filter cartridges for LARGE DIAMETER style housings						
EFSPBB1	1	Blue	4 1/2"	9 3/4"	18	96.20
EFSPBB5	5	Blue	4 1/2"	9 3/4"	18	50.00
EFSPBB20	20	Blue	4 1/2"	9 3/4"	18	42.32
EFSPBB50	50	Blue	4 1/2"	9 3/4"	18	42.32
EFSPBB1-20	1	Blue	4 1/2"	20"	9	111.52
EFSPBB5-20	5	Blue	4 1/2"	20"	9	96.17
EFSPBB20-20	20	Blue	4 1/2"	20"	9	76.96
EFSPBB50-20	50	Blue	4 1/2"	20"	9	76.96





Big-Bubba® High Flow Non-Metallic Filter Housing Features:

Big-Bubba® high flow filters are bigger and better than other non-metallic filter housings because of their economical plastic construction, while pressure rating is nearly equal to stainless steel.

Features:

- Made of glass-reinforced polypropylene for greater strength and chemical resistance.
- Will not dent, rust, chip or corrode.
- Filters accept a single cartridge for convenience.
- Swing-bolt lid closure is easy, safe and secure.
- Pressure release for safety.
- Cartridge "lock" adapter to hold cartridge in place.
- Double o-rings on cartridges for superior sealing.
- Two outlets on opposite sides to allow more flexibility with piping configurations.

Typical Applications:

- Whole house filtration for chlorine, taste, odor and sediment reduction.
- Industrial applications for chemical compatibility.
- Pre-filtration for reverse osmosis.
- Community water systems for cyst reduction.
- Sea water filtration for non corrosion.



Certified to
ANSI-NSF 61



Specifications:

Materials	
Body, cartridge end caps	Glass reinforced PP
Swing Bolts	304SS
O-Ring (lid)	EPDM
Lid closure	Swing Bolt
Pipe Fittings (2 inlet, 1 outlet)	2" slip
Overall height	40"
Width(vessel OD)	12"
Maximum Flow Rate	150 gpm *
Maximum temperature (housing)	125° F
Maximum working pressure	125 psi
Burst test	300 psi
Cycle test (0 to 150 psi)	100,000

* Dependent on micron rating (see pressure drop chart)

Parallel Installation



Parallel installations are recommended to achieve high flow rates, by installing filters on a common manifold, feeding all filters installed in a row.

Series Installation



Series installations are recommended for applications such as surface water filtration, where cartridges having different micron ratings are used.

Part No.	Description	Max Flow Rate	Pipe Fitting	List Price
BBH150	Big-Bubba Housing	150 gpm	2" slip	\$ 3938.73

Big Bubba Filter Cartridges



BBC-P Series



BBC-D Series



BBC-AC Series

Big-Bubba® High Flow Filter Cartridge Features:

Replacement cartridges for Big-Bubba filters, all with double o-ring seals for superior performance.

Cartridges are easy to install, service and replace.

Pleated:

Pleated cartridges are recommended for typical water filtration applications to remove sediment, hard solids and when high efficiency filtration is required. Available in a wide range of micron ratings, including one micron absolute for surface water filtration to reduce Giardia Cysts and Cryptosporidium.

Depth:

Select depth cartridges to remove sediment, gelatinous substances and when chemical compatibility is an issue. Big-Bubba melt blown depth cartridges are 100% polypropylene with EPDM o-rings.

Activated Carbon Cartridges:

Ideal for whole house filtration and other applications to reduce chlorine, tastes, odors and sediment from water. Rated at 5 micron.



Specifications:

	PLEATED	DEPTH
Media	PP or PE	PP
End Caps	PP & FG	PP & FG
Center Tubes	PP	PP
Maximum Flow Rate*	150 gpm	100 gpm
Maximum temperature	125° F	125° F
Maximum Chg pressure (psi)	30	40
Chemical Resistance	Excellent	Excellent
Length (media)	26 1/4"	26 1/4"
O-rings (dual)	EPDM	EPDM

* Flow rates based on each specific application, micron rating, solids content and other factors. End user should consider these factors when selecting the filter housing (or housings) needed for their particular requirement.

PLEATED Cartridge Pressure drop

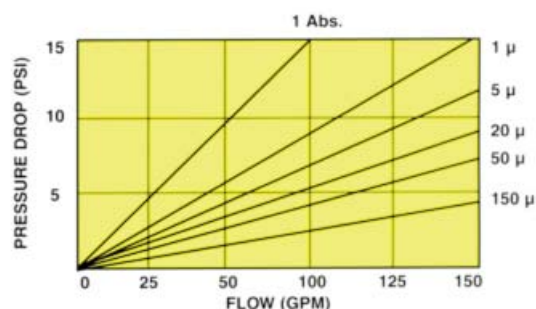

Part Number	Micron	Media Type	Seals	Ctn Qty	List Price
PLEATED					
BBC-150-P5	5	Polypropylene	Double O-rings	1	\$ 1084.29
BBC-150-P20	20	Polypropylene	Double O-rings	1	1007.85
BBC-150-P50	50	Polypropylene	Double O-rings	1	933.30
DEPTH					
BBC-150-D1	1	Polypropylene	Double O-rings	1	307.97
BBC-150-D5	5	Polypropylene	Double O-rings	1	275.70
BBC-150-D20	20	Polypropylene	Double O-rings	1	271.32
BBC-150-D50	50	Polypropylene	Double O-rings	1	289.84
ACTIVATED CARBON					
BBC-150-AC	5 nominal	Activated carbon	Double O-rings	1	1877.79



HROK4



HROK5



HARVARD Residential Reverse Osmosis System Features:



- Pre-assembled, easy to install 4 or 5 stage RO system.
- Complete with all installation accessories and instructions.
- High rejection, thin film membrane up to 98% efficient with 50 gal/day (4 stage) or 75 gal/day (5 stage) capacity. (Note: Feed water requirements below)
- NSF Standard 58 listed, CE certified, polypropylene tank rated to 100 psi.
- All fittings, tubing, housings, valves, cartridges and membranes are NSF listed or made from NSF listed materials.
- Automatic shut-off valve made from NSF listed materials.
- Lead free, long reach chrome faucet included. Meets California AB1953 requirements.
- Cartridges, valves, fittings, sump wrench, white mounting bracket and complete installation instructions included.

NOTE: Every HROK, HROK-BP has been pressure and water tested after assembly. Due to the variety of installation methods, environments and systems components, standard AGI warranty does not apply to HROK, HROK-BP systems or components.

Feed Water Requirements:

- Maximum TDS: 2,000 ppm
- Maximum Iron: 0.3 ppm
- Maximum hardness: 12 gpg
- Temperature: 45-100°F
- Maximum hydrogen sulfate: 0
- Maximum manganese: 0.05 ppm
- Pressure: 40-85 psi (min/max)
- pH: 4-10

HROK Systems Include:

- NSF listed John Guest style quick connect fittings.
- Filter housings made from NSF listed materials.
- NSF Standard 58, CE listed polypropylene tank. (10" diam x 15" high)
- 5 micron sediment pre-filter cartridge.
- Activated GAC granular carbon cartridge (5 stage)
- Activated carbon block cartridge.
- NSF listed Dow/Filmtec thin film membrane. 50 gpd (4 stage) 75 gpd (5 stage).
- Inline post carbon polishing cartridge.
- Automatic shutoff valve made with NSF materials.
- Long reach, lead free chrome faucet, meets California AB1953.
- Sump wrench, tubing, service valve, check valve, ball valves, flow restrictor included.
- Complete installation instructions.
- 5 stage with booster pump for sink water pressure lower than 40 psi.
- Booster pump rated to 125 psi with 110V/60 Hz, 24VDC power.

Note: For cold water use only. Do not install on hot water line. To insure that the membrane is functioning properly, the product water must be tested regularly.

The Benefits (nominal ion rejection characteristics)*

Aluminum	96-98%	Manganese	96-98%
Ammonium	80-90%	Mercury	94-97%
Borate	30-50%	Nickel	96-98%
Boron	50-70%	Nitrate	90-95%
Bromide	90-95%	Orthophosphate	96-98%
Cadmium	93-97%	Phosphate	95-98%
Calcium	93-98%	Polyphosphate	96-98%
Chloride	92-95%	Potassium	92-96%
Chromate	85-95%	Radioactivity	93-97%
Copper	96-98%	Silica	80-90%
Cyanide	85-95%	Silicate	92-95%
Fluoride	92-95%	Silver	93-96%
Hardnes Ca & Mg	93-97%	Sodium	92-98%
Iron	96-98%	Sulfate	96-98%
Lead	95-98%	Thiosulfate	96-98%
Magnesium	93-98%	Zinc	96-98%

* The above percent rejection is for reference only. Actual rejection will depend heavily on the exact chemistry, temperature, pressure & TDS content of the feed water.

Part No.	Description	List Price
HROK4	4 stage RO system, 50 gpd	\$ 553.73
HROK5	5 stage RO system, 75 gpd	558.45
HROK5BP	5 stage RO system, 75 gpd w/ booster pump	867.24
HROK4MEM50	Dow/Filmtec TFC membrane 50 gpd	151.97
HROK5MEM75	Dow/Filmtec TFC membrane 75 gpd	171.50
HROKTANK32	3.2 gal plastic tank, NSF58/CE	163.04
HROKASV	Auto shutoff valve	11.81

Economy Drinking Water Systems

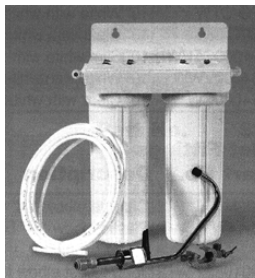

DWS2

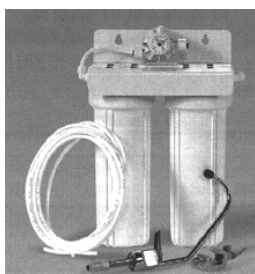

DWS2M



Economy Drinking Water System Features:

- Pre-assembled, easy to install.
- Complete with all installation accessories and instructions.
- Carbon and sediment filter cartridges sold separately.
- Select the appropriate carbon cartridge to reduce taste and odor, chlorine, giardia, cryptosporidium, VOC's, lead and mercury.

DWS Series Includes:

- NSF listed housings
- NSF listed John Guest fittings.
- NSF listed tubing.
- Lead free, long reach chrome faucets. Meets State of California requirements.
- WQA validated, 1800 gallon, patented automatic shut-off valve made from NSF listed materials. (DWS-M Series only)
- White aluminum bracket with stainless steel mounting screws.
- Saddle valve.
- Carbon filter cartridges **NOT** included.

Part No.	Description	List Price
DWS2	2 Stage system (no Auto shut-off)	\$ 272.82
DWS2M	2 Stage system w/ Auto shut-off	371.88

Available Carbon
Filter Cartridges
See page 4.19-4.20
for description and
list prices.



Series	PFC	PFGAC	PFCEP	PFCC	PFCBC	PFCBR2
Sediment	5 micron	N/A	5 micron	N/A	1 micron	0.5 micron
Taste & Odor	Yes	Yes	Yes	Yes	Yes	Yes
Chlorine	Yes	Yes	Yes	Yes	Yes	Yes
Cyst Reduction Giardia & Cryptosporidium	No	No	No	No	Yes	Yes
VOC Reduction	No	No	No	Yes	Yes	Yes
Lead & Mercury	No	No	No	No	No	Yes

Styles:

- Standard
- Slim Line™
- Valve-in-Head
- High Temperature
- Big Blue®

Materials:

- Opaque - Reinforced Polypropylene
- Clear - FDA Styrene-Acrylonitrile (SAN)

Applications:

- Residential/Whole house,
Commercial/Industrial, Institutional, OEM

ISO 9001

DO NOT over tighten fittings used to install filter housing. Over tightening will result in cracking the housing threads and will void all limited warranties. Only PTFE thread seal tape OR non-PTFE based thread seal paste approved for plastic threads should be used to seal filter housing threads - NOT BOTH.

PFH75B

PFH75C
Standard Housing Features:

- Ideal for a wide range of residential, commercial and industrial applications.
- 3/4" NPT inlet/outlet.
- Available in 10" and 20" lengths.
- Equipped with pressure relief button on the inlet side of the head.
- NPsuffix - no pressure relief button.
- Available with either clear or opaque sump.
- Maximum operating pressure 125 PSI @ 125° F

Part No.	Style	Sump	Head	Inlet/Outlet	Length	Width	Ctn Qty	List Price
PFH75B	Standard	Blue	Black	3/4" NPT	12 1/4"	5 1/8"	12	\$ 99.67
PFH75C	Standard	Clear	Black	3/4" NPT	12 1/4"	5 1/8"	12	121.03
PFH75B20	Standard	Blue	Black	3/4" NPT	22 3/8"	5 1/8"	8	162.10

PFH38SLC5

PFH38SLC
Slim Line™ Housing Features:

- Ideal for a wide range of residential, commercial and industrial applications.
- 3/8" NPT inlet/outlet.
- Available in 5" and 10" lengths.
- Equipped with pressure relief button on the inlet side of the head.
- Available with either clear or opaque sump.
- Maximum operating pressure 125 PSI @ 125° F

Part No.	Style	Sump	Head	Inlet/Outlet	Length	Width	Ctn Qty	List Price
PFH38SLC5	Slimline	Clear	Blue	3/8" NPT	7"	4 3/8"	12	111.65
PFH38SLB	Slimline	Blue	Black	3/8" NPT	11 3/4"	4 3/8"	12	59.21
PFH38SLC	Slimline	Clear	Blue	3/8" NPT	11 3/4"	4 3/8"	12	107.72

DO NOT over tighten fittings used to install filter housing. Over tightening will result in cracking the housing threads and will void all limited warranties. Only PTFE thread seal tape OR non-PTFE based thread seal paste approved for plastic threads should be used to seal filter housing threads - NOT BOTH.

ISO 9001

PFH75V Series

Valve-in-Head Housing Features:

- Valve-in-Head (VIH) feature closed both the inlet and outlet ports simultaneously with a half turn of the handle.
- Makes cartridge change outs quick and easy.
- Available in 5", 10" and 20" lengths.
- Includes pressure relief button on the inlet side of the head.
- Available with either clear or opaque sump.
- Maximum operating pressure 125 PSI @ 125° F

Part No.	Style	Sump	Head	Inlet/Outlet	Length	Width	Ctn Qty	List Price
PFH75VB	VIH	Blue	Black w/ VIH	3/4" NPT	12 1/2"	5 1/8"	12	\$ 165.90
PFH75VC	VIH	Clear	Blue w/ VIH	3/4" NPT	12 1/2"	5 1/8"	12	156.90
PFH75VB20	VIH	Blue	Black w/ VIH	3/4" NPT	22 3/8"	5 1/8"	8	242.75

PFH75HR

High Temperature Housing Features:

- Low cost alternative to stainless and carbon steel housings.
- Durable glass reinforced nylon construction.
- Available with 1/2" and 3/4" NPT inlet/outlet
- Maximum temperature rating of 160°F.
- Maximum operating pressure 125 PSI.

Part No.	Style	Sump	Head	Inlet/Outlet	Length	Width	Ctn Qty	List Price
PFH75HR	High Temp	Red	Red	3/4" NPT	12 1/8"	5 1/8"	12	\$ 521.38

Big Blue

Big Blue® Large Diameter Housing Features:

- Large capacity housing designed for whole house and high-flow applications.
- Available with 3/4", 1" or 1 1/2" NPT inlet/outlet.
- Available in 10" and 20" lengths.
- Equipped with a pressure relief button on the inlet side of the head.
- Accepts large capacity 4 1/2" diameter cartridges.
- Maximum operating pressure 100PSI @ 100° F
- PFHD10 packed in white box with a spanner wrench.
- Bulk packed without spanner wrench

Part No.	Style	Sump	Head	Inlet/Outlet	Length	Width	Ctn Qty	List Price
CPFHD75	Big Blue®	Blue	Black	3/4" NPT	13 1/8"	7 1/4"	6	\$ 142.99
CPFHD75BB	Big Blue®	Blue	Black	3/4" NPT	23 3/8"	7 1/4"	4	202.14
CPFHD10	Big Blue®	Blue	Black	1" NPT	13 1/8"	7 1/4"	6	175.28
PFHD10	Big Blue®	Blue	Black	1" NPT	13 1/8"	7 1/4"	1	246.31
PFHD10HFP20	Big Blue®	Blue	Black	1" NPT	23 3/8"	7 1/4"	4	324.92
PFHD15HFP20	Big Blue®	Blue	Black	1 1/2" NPT	23 3/8"	7 1/4"	4	254.08

Cartridge Selection Guide

ISO 9001

SEDIMENT



Series	PFWP	PFS	PFR	PFP	PFPD
Micron Rating	5, 25, 50	20	30, 50	1, 5, 25	1, 5, 25
Avail Lengths	10"	10" & 20"	10"	10" & 20"	10" & 20"
Construction Style	String Wound	Pleated	Pleated	Spun	Therm Bonded
Medium	Polypropylene	Cellulose	Polyester	Polypropylene	Polypropylene
Filtration Style	Depth	Surface	Surface	Depth	Depth
Applications	Chlorinated & Non-Chlorinated	Chlorinated	Chlorinated & Non-Chlorinated	Chlorinated & Non-Chlorinated	Chlorinated & Non-Chlorinated
Avail for Big Blue	Yes	Yes	Yes	No	No

TASTE/ODOR & SEDIMENT



Series	PFC	PFGAC	PFCEP	PFCBC	PFCBR2
Sediment	5 micron	N/A	5 micron	0.5 micron	0.5 micron
Taste & Odor	Yes	Yes	Yes	Yes	Yes
Chlorine	Yes	Yes	Yes	Yes	Yes
Cyst Reduction <i>Giardia & Cryptosporidium</i>	No	No	No	Yes	Yes
VOC Reduction	No	No	No	Yes	Yes
Lead & Mercury	No	No	No	No	Yes
Avail for Big Blue	No	Yes	Yes	Yes	No
Est Filter Life	6 mo.	12 mo.	12 mo.	12 mo.	12 mo.

Sediment Cartridges:

- String wound
- Pleated cellulose
- Pleated polyester
- Spun polypropylene
- Thermally Bonded polypropylene

**PFWP
String
Wound**

**PFWP-BB
String
Wound**

**PFWPX-BB
Fibrillated**

ISO 9001
String Wound Cartridges
PFWP & PFCW Series String Wound Polypropylene Cartridges

- Ideal for fine sediment reduction, including sand, silt, scale and rust.
- These cord wound cartridges are compatible with most acids, alkalis, corrosive fluids & gases.
- Precise winding pattern ensures high efficiency rate and high dirt loading capacity.
- Core material: FDA Polypropylene
- Max temperature: 180° F
- General purpose filtration.

PFWP-BB Series String Wound Polypropylene Cartridges

- Constructed of fibrous polypropylene over polypropylene core.
- Note: An antistatic agent has been used in the processing of the fibrous polypropylene and may cause some foaming in water.

PFWPX-BB String Wound Fibrillated Polypropylene Cartridges

- Constructed of fibrillated polypropylene on a polypropylene core.
- For use when pressures require minimization of exactables and/or fiber migration.

Part No.	Medium	Type of Construction	Micron Opening	GPM	Length	Ctn Qty	List Price
Standard Housings 2 3/8" diameter							
PFWP1	Polypropylene	Wound	1	5	9-7/8"	30	\$ 9.83
PFWP5	Polypropylene	Wound	5	5	9-7/8"	30	9.76
PFWP10	Polypropylene	Wound	10	5	9-7/8"	30	9.76
PFWP20	Polypropylene	Wound	20	5	9-7/8"	30	9.76
PFWP25	Polypropylene	Wound	25	5	9 7/8"	30	9.83
PFWP30	Polypropylene	Wound	30	5	9-7/8"	30	9.76
PFWP50	Polypropylene	Wound	50	5	9-7/8"	30	10.42
PFCWMF	Polypropylene	Wound	med. fine	10	9 7/8"	24	14.29
PFCW50	Polypropylene	Wound	50	10	9-7/8"	24	17.21
PFWP1-20	Polypropylene	Wound	1	5	20"	30	21.56
PFWP5-20	Polypropylene	Wound	5	5	20"	30	19.99
PFWP10-20	Polypropylene	Wound	10	5	20"	30	19.99
PFWP20-20	Polypropylene	Wound	20	5	20"	30	19.99
Large Diameter Housings 4 1/2" diameter							
PFWP.5BB97P	Polypropylene	Wound	0.5	5	9-7/8"	9	41.48
PFWP1BB97P	Polypropylene	Wound	1	5	9-7/8"	9	41.51
PFWP5BB97P	Polypropylene	Wound	5	5	9-7/8"	9	41.51
PFWP10BB97P	Polypropylene	Wound	10	5	9-7/8"	9	41.51
PFWP20BB97P	Polypropylene	Wound	20	5	9-7/8"	9	41.51
PFWP30BB97P	Polypropylene	Wound	30	5	9-7/8"	9	41.51
PFWP50BB97P	Polypropylene	Wound	50	5	9-7/8"	9	41.51
PFWP.5BB20P	Polypropylene	Wound	0.5	5	20"	9	72.63
PFWP1BB20P	Polypropylene	Wound	1	5	20"	9	72.63
PFWP5BB20P	Polypropylene	Wound	5	5	20"	9	67.23
PFWP10BB20P	Polypropylene	Wound	10	5	20"	9	67.23
PFWP20BB20P	Polypropylene	Wound	20	5	20"	9	67.23
PFWP25BB20P	Polypropylene	Wound	25	5	20"	9	67.23
PFWP50BB20P	Polypropylene	Wound	50	5	20"	9	71.90
PFWP60BB20P	Polypropylene	Wound	60	5	20"	9	68.95
PFWPX5BB97P	Fibrillated Polypropylene	Wound	5	10	9-7/8"	8	81.60
PFWPX10BB97P	Fibrillated Polypropylene	Wound	10	15	9-7/8"	8	81.20
PFWPX25BB97P	Fibrillated Polypropylene	Wound	25	20	9-7/8"	8	86.58
PFWPX50BB97P	Fibrillated Polypropylene	Wound	50	30	9-7/8"	8	93.80



PFCEP

PFCEP Series Pleated Cellulose Cartridge

- Used for general water filtration purposes.
- This filter is comprised of 6 square feet of cellulose, providing maximum surface area and strength to prolong cartridge life.
- End caps fused to body assure an integral sealing area and prevent by-pass.
- Nominal 20 micron rating.
- Temperature Rating: 40-125°F

ISO 9001



Part No.	Medium	Type of Construct	Micron Opening	GPM	Fits Housing	Length	Ctn Qty	List Price
PFCEP2020	Cellulose	Pleated	20	10	Standard	20"	14	43.73
PFCEP20BB	Cellulose	Pleated	20	20	Big Blue	9-3/4"	8	56.01
PFCEP2020BB	Cellulose	Pleated	20	20	Big Blue	20"	6	101.61



PFR

PFR Series Pleated Polyester Cartridges

- Excellent for water well, institutional and light industrial applications.
- Four square feet of media on standard and 20 square feet of media on BB
- Pleated polyester fabric filter can be washed and resued several times. †Reuse is not recommended in potable water applications.
- Synthetic construction will not support bacteria growth.
- Available with nominal 30 and 50 micron ratings.

Part No.	Medium	Type of Construction	Micron Opening	GPM	Fits Housing	Length	Ctn Qty	List Price
PFR30	Polyester	Pleated	30	12	Standard	9-3/4"	24	40.74
PFR50	Polyester	Pleated	50	12	Standard	9-3/4"	24	41.08
PFR30BB	Polyester	Pleated	30	25	Big Blue	9 3/4"	8	63.66
PFR50BB	Polyester	Pleated	50	25	Big Blue	9 3/4"	8	59.82



PFCEP

PFCEP Series Pleated Cellulose Polyester Cartridges

- 6 sq. feet of media on standard and 16 sq.ft. on BB provide additional surface area and allow increased dirt holding capacity and low pressure drop
- Ideal for high flow applications.
- Cartridges are encapsulated in polyester outer sheath for added support.

Part No.	Medium	Type of Construction	Micron Opening	GPM	Fits Housing	Length	Ctn Qty	List Price
PFCEP5	Cellulose Polyester	Pleated	5	15	Standard	9-3/4"	24	24.17
PFCEP20	Cellulose Polyester	Pleated	20	15	Standard	9-3/4"	24	25.89
PFCEP5BB	Cellulose/Poly Blend	Pleated	5	30	Big Blue	9-3/4	8	56.47
PFCEP5-20BB	Cellulose/Poly Blend	Pleated	20	30	Big Blue	9-3/4	6	119.67

PFP

PFP Series Spun Polypropylene Fiber Cartridges

- Excellent bacteria and chemical resistance.
- Manufactured from pure 100% polypropylene.
- Fibers are carefully spun to form a cartridge w/ variable density. The density increases closer to core.
- Available in three different lengths and micron ratings



Part No.	Medium	Type of Construct	Micron Opening	GPM	Fits Housing	Length	Ctn Qty	List Price
PFP5-478	Polypropylene	Spun	5	5	Compact	4-7/8"	24	\$ 17.27
PFP1	Polypropylene	Spun	1	10	Standard	9-7/8"	24	24.39
PFP5	Polypropylene	Spun	5	10	Standard	9-7/8"	24	20.21
PFP25	Polypropylene	Spun	25	10	Standard	9-7/8"	24	21.18
PFP1-20	Polypropylene	Spun	1	20	Standard	20"	20	50.42
PFP5-20	Polypropylene	Spun	5	20	Standard	20"	20	37.61
PFP25-20	Polypropylene	Spun	25	20	Standard	20"	20	38.53



PFDGD Spun Polypropylene Dual Gradient Cartridge

- Dual gradient filter included pre and post filtration reduce large and fine particles to enhance cartridge performance.
- Eliminates need for multiple housing step-down systems
- Three times the dirt holding capacity

Part No.	Medium	Type of Construct	Micron Opening	GPM	Fits Housing	Length	Ctn Qty	List Price
PFDGD2501-10	Polypropylene	Spun	Pre 25/Post 1	10	Big Blue	10"	8	\$ 65.50
PFDGD2501-20	Polypropylene	Spun	Pre 25/Post 1	20	Big Blue	20"	6	119.50
PFDGD5005-10	Polypropylene	Spun	Pre 50/Post 5	10	Big Blue	10"	8	62.61
PFDGD5005-20	Polypropylene	Spun	Pre 50/Post 5	20	Big Blue	20"	6	115.76
PFDGD7525-10	Polypropylene	Spun	Pre 75/Post 25	10	Big Blue	10"	8	62.15
PFDGD7525-20	Polypropylene	Spun	Pre 75/Post 25	20	Big Blue	20"	6	114.18

PFPD

PFPD Series Thermally Bonded Polypropylene Cartridge

- Manufactured from pure 100% polypropylene.
- 98% efficient, more efficient than resin bonded cartridges.
- Thermal bonded micro-fiber construction.
- Withstands high temperature and pressure differentials.
- No fiber release, brittleness or growth/shrinkage due to climate conditions.
- Available in a wide range of micron ratings and lengths.

Part No.	Medium	Type of Constructions	Micron Opening	GPM	Fits Housing	Length	Ctn Qty	List Price
PFPD-10	Polypropylene	Therm Bonded	10	10	Standard	9-7/8"	24	\$ 20.86
PFPD-5	Polypropylene	Therm Bonded	5	10	Standard	9-7/8"	24	21.91

Taste/Odor/Sediment Cartridges:

- Carbon Impregnated
- Granular Activated Carbon (GAC)
- Carbon Block

PFC1
PFC Series Carbon Impregnated Cellulose Cartridges

- Dual purpose cartridge provides taste/odor/chlorine reduction plus sediment filtration.
- A combination of carbon and cellulose creates a dual filter used for removing fine particles and reducing unwanted tastes and odors occasionally found in tap water.
- Excellent “polishing” filter when used in process or closed loop systems.
- Design maximized dirt holding capacity.

Part No.	Medium	Type of Construction	Micron Opening	Chlorine Reduction gal	Fits Housing	Length	Ctn Qty	List Price
PFC2	Carbon/Cellulose	Wrap	5	2500 @ 2 gpm	Compact	4 3/4"	24	\$ 32.22
PFC1	Carbon/Cellulose	Wrap	5	5000 @1 gpm	Standard	9 7/8"	24	33.03
PFC1-20	Carbon/Cellulose	Wrap	5	10,000 @1 gpm	Standard	20"	14	62.71

PFGAC

PFCC
PFGAC Series Granular Activated Carbon (GAC) Cartridges

- Designed to reduce or eliminate unwanted tastes and odors such as chlorine.
- Water enters the filter from the bottom and travels through the entire charcoal bed before exiting at the top. This filtration technique maximizes contact time with carbon to insure maximum absorption.
- Internal expansion pad maintains a tight compact column to minimize channeling or by-pass.
- Nominal 20 micron post filter reduces the content of carbon fines & suspended particles

PFCC Series Granular Activated Coconut Carbon Cartridges

- Coconut Shell based activated carbon to reduce organic chemicals like EDB, TCE & THM plus chlorine.
- Nominal 20 micron post filter to reduce carbon fines and other particles.

Part No.	Medium	Type of Construction	Micron Opening	Chlorine Reduction gal	Fits Housing	Length	Ctn Qty	List Price
PFGAC5	Granular Carbon	Canister	N/A	750 @ .5gpm	Compact	4 7/8"	24	\$ 36.87
PFGAC10	Granular Carbon	Canister	N/A	5000 @ 1gpm	Standard	9 7/8"	12	53.28
PFGAC20	Granular Carbon	Canister	N/A	10000 @ 2gpm	Standard	20"	6	125.69
PFGACBB	Granular Carbon	Canister	N/A	12500 @ 2gpm	Big Blue	9 3/4"	8	136.74
PFGAC20BB	Granular Carbon	Canister	N/A	30000@ 4gpm	Big Blue	20"	10	330.84
PFCC10	Granular Carbon	Canister	N/A	7500 @ 1gpm	Standard	9 3/4"	12	65.26



PFCEP



PFCBC



PFCBR

PFCEP Series Carbon Block Cartridges

- Designed for post RO applications.
- Minimizes chlorine and pH rise and produces low extractables.
- Acid washed coconut formulation
- Light brown end cap

PFCBC Series Carbon Block Cartridges

- Designed to reduce VOC's, chlorine, color bodies, plus remove fine sediment from the residual, commercial & industrial liquids. Filters giardia & cryptosporidium cysts from potable water.
- High chemical adsorption provided by acid washed bituminous powdered, activated carbon block.
- Sediment filter eliminates unwanted particles down to 0.5 nominal micron.
- Excellent polishing filter or prefilter.

PFCBR Series Carbon Block Multimedia Cartridge

- Removes both metals and chemicals with one cartridge.
- All purpose carbon block cartridge removes unpleasant tastes and odors plus greatly reduces the amount of dissolved heavy metals and the taste of chlorine.
- Removes lead up to 96% and mercury up to 98%.
- Also removes up to 99% of giardia and cryptosporidium cysts and sediment particles down to .5 micron in size.



ISO 9001



Part No.	Medium	Type of Construction	Micron Opening	Chlorine Reduction gal	Fits Housing	Length	Ctn Qty	List Price
PFCEPBB20	Acid washed	Carbon Block	5	32000 @ 4 gpm	Big Blue	20"	6	\$ 247.89
PFCBC10	Acid washed	Carbon Block	0.5	20000 @ 1 gpm	Standard	9 3/4"	12	104.90
PFCBC20	Acid washed	Carbon Block	0.5	45000 @ 1 gpm	Standard	20"	12	162.03
PFCBCBB	Acid washed	Carbon Block	0.5	50000 @ 2 gpm	Big Blue	9 3/4"	4	248.59
PFCBCBB20	Acid washed	Carbon Block	0.5	150000 @ 4 gpm	Big Blue	20"	6	406.00
PFCBR2-10	Acid washed	Carbon Block	0.5	20000 @ 1 gpm	Standard	9 3/4"	12	138.56

Specialty Cartridges



PFRFC

PFRFC Series Radial Flow Carbon Cartridges

- Radial flow carbon cartridge designed for gas and liquid filtration.
- Activated carbon bed and inner layers of polypropylene remove particles over nominal 7 microns.
- Removes organic and particulate contaminants from plating, acid alkaline and hydrocarbon solutions when used for liquid filtration.



ISO 9001



Part No.	Medium	Type of Construction	Micron Opening	GPM	Fits Housing	Length	Ctn Qty	List Price
PFRFC93	Carbon/Polypropylene	Canister	NR	1-3	Standard	9 3/4"	24	\$ 87.31
PFRFCBB	Carbon/Polypropylene	Canister	25	3-10	Big Blue	9 3/4"	8	208.52
PFRFC20BB	Carbon/Polypropylene	Canister	25	5-15	Big Blue	20"	6	416.26



Housing & Cartridge Combination Kit Features:

- Each kit contains one complete housing, one cartridge and installation sheet.

ISO 9001

Part No.	Size	Sump	Cartridge	List Price
Housing & Cartridge Combination Kits				
PFH75C-S1	3/4" standard	transparent	general purpose/sediment	\$ 176.26
PFH75C-C1	3/4" standard	transparent	taste/odor/sediment	198.24

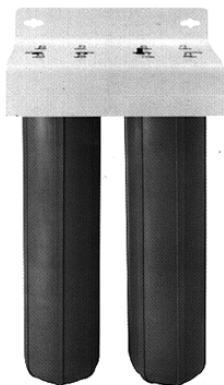
BBFS22

BBFS Filtration System Features:

- Large capacity, multi-housing system.
- Allows for greater cartridge capacity and high flow rates.
- Consists of (2) or (3) 20" big Blue Filter housings with 1" NPT I/O mounting bracket.
- Designed for residential, commercial and industrial applications.
- System does NOT include filter cartridges.

Part No.	Description	List Price
BBFS22	2 housing Big Blue System (15 1/4" x 8 1/2" x 26 1/2")	\$ 789.71
BBFS222	3 housing Big Blue System (23 1/4" x 8 1/2" x 26 1/2")	1164.72

"PF" Series Housing Replacement Parts:

Including replacement heads, sumps, o-rings, mounting brackets and wrenches.

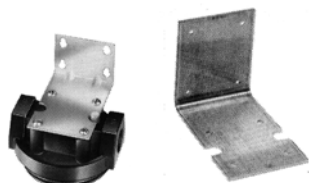
PFMB75

PFMC1
PFWBBS

PFSW

Part Number	Description	Ctn Qty	List Price
PFC75BL	Blue Head for 3/4" Housing	1	\$ 52.47
PF75CS	Clear Sump for 3/4" Housing	1	146.70
PFBBS	Big Blue Sump only	1	145.63
PFOR38	O-Ring for 3/8" Series	1	9.60
PFOR75	O-Ring for 3/4" Series	1	15.22
PFBBOR	O-Ring for Big Blue	1	24.96
PFMB3814	Mounting Bracket for 3/8"	1	18.57
PFMB75	Mounting Bracket for 3/4" - U Shaped	1	35.12
PFMC1	Mounting Bracket for 3/4" caps w/ Bosses	1	27.10
PFWBBS	Mount Bracket for 1-1 1/2" Big Blue, Zinc plated	1	160.82

Housing Wrenches

PFSW1	3/8" Black Wrench for Slimline Housing	1	22.65
PFSW2	3/4" Black Wrench for Standard Housing	1	22.92
PFSW3	Black Wrench for Large Diameter Housing	1	34.10

PFOA/PFOS Filtration Systems Features:

- Professional grade PFOA/PFOS reduction systems for whole house or point of use undersink applications.
- Systems are certified by IAPMO R&T to reduce up to 98% of PFOA/PFOS, commonly known as “forever chemicals”.
- Integrated pressure relief valve for easier cartridge change-outs.
- Complete systems include housing, cartridge, wrench, mounting bracket with screws and installation and operation manual.

NEW



Systems Certified by IAPMO R&T to NSF/ANSI 53



CHLORPLUS PROTECT™ System Features:

- For undersink point of use.
- 10" filter housing
- 3/4" FPT inlet
- Maximum 1 gpm service flow rate.
- Also features premium sediment, chlorine and chloramine reduction.



Part No.	Description	Ctn	Cty	List Price
150742	Chlorplus™ Protect 10" undersink system kit	1		\$ 361.99
655226-43	Chlorplus™ Protect 10" replacement cartridge	12		184.47



FLOPLUS PROTECT System Features:

- Whole house use.
- 20" filter housing
- 1 1/4" FPT inlet
- Maximum 5 gpm service flow rate.
- Maximum filtration with minimum pressure drop.



Part No.	Description	Ctn	Cty	List Price
150736	FloPlus Protect 20"BB whole house system kit	1		\$ 783.92
655223-43	FloPlus Protect 20" BB replacement cartridge	6		422.28

Specifications:

SYSTEM	CHLORPLUS	FLOPLUS
Housing Size:	10" Heavy Duty	20" Heavy Duty
Inlet Size:	3/4" FPT	1 1/2" FPT
Flow Rate:	1 gpm	5 gpm
Housing Material:	Polypropylene	Polypropylene
System Dimensions:	5.13" W x 12.23" H	7.45" W x 23.22" H
Cartridge Type:	Carbon Block	FibreDyne Carbon Block
Micron Rating:	1	0.5
Capacity:	1,000 gal	15,000 gal
Approx. Filter Life:	4-5 months	4-5 months
Contaminant Reduction:	PFOA/PFOS	PFOA/PFOS
Certification:	NSF/ANSI Std. 53	NSF/ANSI Std. 53
Feed Pressure Range:	0-125 psi	30-90 psi
Temperature Range:	40°-100°F	40°-100°F
Replacement Cartridge:	150742	150736

Installation and Operation Tips:

- Choose a mounting location suitable to support the full weight of the system while operating.
- Make sure to properly lubricate the O-ring prior to use.
- Install vertically with sump hanging down.
- Allow clearance below the cartridge for easy replacement.
- Replace cartridge if flow rate decreases.
- Do not exceed service flow rate.
- Inspect O-ring during each cartridge change. Lubricate or replace if necessary.
- Filter life dependent on gallon usage and overall incoming water quality.
- Please install a 5 micron sediment filter before these systems.

Chlorplus™ is a trademark of Pentair.

Saddle Tap Valve/Kit and Iron Out®

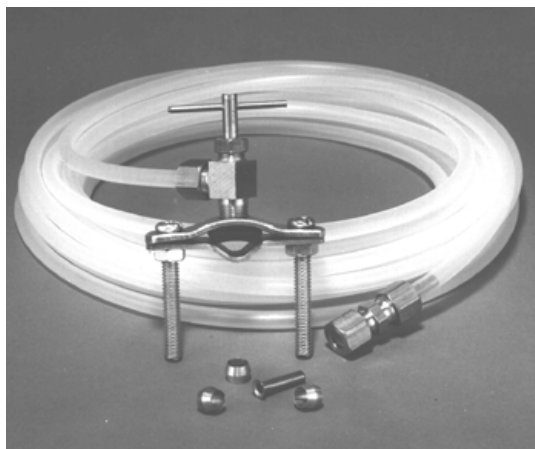

NO LEAD Brass Saddle Tap Valve & Kit Features:

- Self piercing tap valve and clamp for 3/8" to 1" OD copper tube or 3/8" to 3/4" iron pipe.
- Plastic sleeve, brass compression nut and brass or no lead brass insert (for reinforcing polyethylene tubing).
- Brass compression union for connecting polyethylene tubing to 1/4" water inlet at refrigerator, humidifier or cooler.
- 25 feet of 1/4" OD polyethylene tubing.
- The saddle tap valve eliminates plumbing connections and fittings.
- Supplies water to most humidifiers, evaporative coolers and refrigerators with automatic ice maker or water dispenser in door.
- Use for installation of Reverse Osmosis and Chemical Contaminant Filter Systems.
- For use on copper tube or iron pipe.

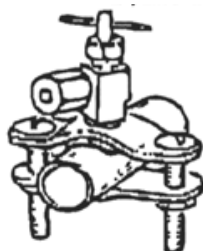

Part Number	Description	Ctn Qty	List Price
HTVK381NL	NO LEAD Brass Tapping Valve Kit fits 3/8" -1" OD copper tube or 3/8"-3/4" iron pipe	6	\$ 32.44
PFSTVNL	No Lead Brass Saddle Tapping Valve Only	10	9.51

Super Iron Out®

Removes the toughest rust and iron stains quickly and easily from white clothes, laundry, toilets, sinks, tubs, dishwashers, exterior surfaces and much more. Also keeps water softeners clean and operating at peak efficiency.



Part Number	Description	Ctn Qty	List Price
IOUT30	Iron Out, 28 oz.	6	\$ 19.90
IOUT5	Iron Out, 76 oz.	6	50.87



Harmsco™ Up Flow Cartridge Filtration

A design so superior it's patented!

Harmsco® Up-Flow Cartridge filters outperform conventional filter designs because the outlet is located above the inlet to eliminate air entrapment during operation. With Up-Flow Filters, liquid enters the vessel through the inlet, located at the bottom of the filter. As the liquid travels upward, it flows through the media, past the top seal, separating the dirty and clean water chambers, and down the standpipe as it exits the filter. Because the top of the standpipe is located above the top seal, air is self-purged from the filter to eliminate vents and improve filtration efficiency.

Features:

- Constructed of low carbon 304 stainless steel for durability and long life.
- All stainless steel components are electro-polished for superior finish, resistance to corrosion and increased durability.
- Individual studs for optimum security. No v-clamps with only one bolt to secure lids.
- Wing nuts are used so no tools are required. Finger tight is generally sufficient. Hex nuts are recommended with 75 ft-lbs. or torque above 100 psi.
- All filters are pressure rated to 150 PSI (10bar) and hydrostatically tested.
- Cartridges in some models are arranged in a single "cluster" for easy cartridge installation, removal and service.

Typical Applications:

- Drinking water
- Bottled water
- Ground Water
- Asbestos abatement
- Chill water
- Industrial
- Process water
- Beverages
- Surface water
- Plating baths
- Desalination prefilters
- Commercial
- R/O pre-filtration
- Drinking fountains
- Rinse water
- Cooling water
- Ultrafiltration
- Municipal
- Industrial waste water
- Whole house filtration
- Environmental
- Heating loops
- Spray nozzles

Harmsco Up-Flow Filters Outperform the Competition!

With conventional cartridge filter designs, inlets are located **above** outlets. Therefore, vents are required to relieve air that can accumulate within the filter vessel during operation. By-pass can also occur when unfiltered liquid drains to the sump while the cartridges are removed, when the filter is put back in service. Please see diagrams, below:

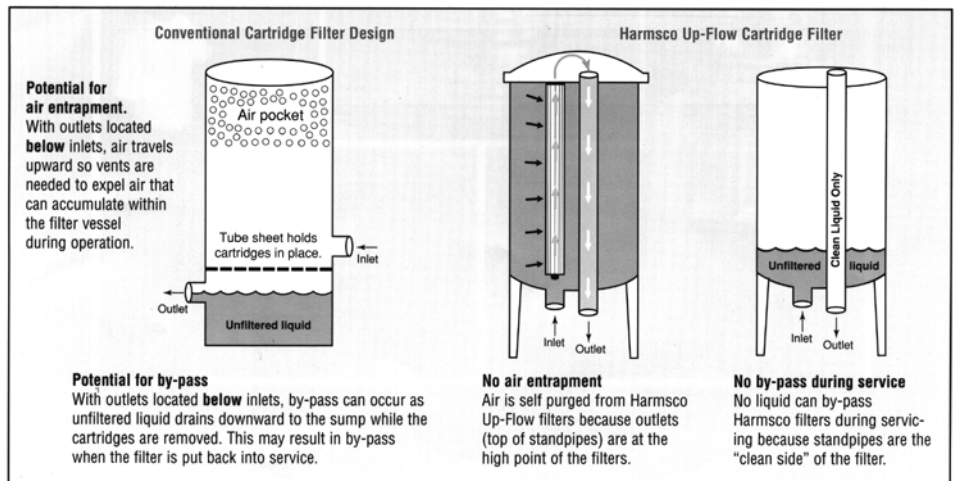

Easy Cartridge Installation and Replacement:

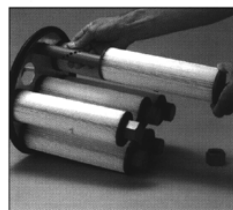

Install cartridge on holding rod.

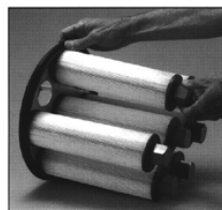

Tighten threaded pipe cap securely.

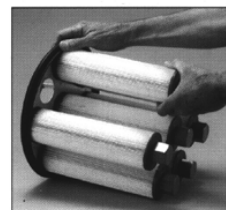

Hold cartridge by end cap and rotate until secure.

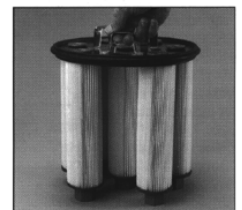

Cartridge cluster is ready for installation.

Two Filter Styles Cartridge Cluster Filters and High Capacity Models

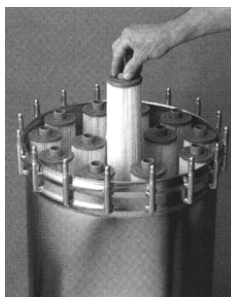
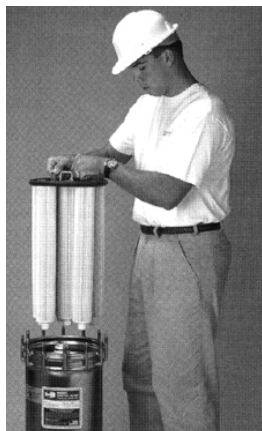

Cartridge Cluster Filters

Cartridges in the HIF7, HIF14, HIF16, HIF21 and HIF24 models are arranged in a single "cartridge cluster", so all cartridges are removed at one time.

Hi Capacity Filters

Cartridges in the HIF42, HIF75, HIF100, HIF150-FL, HIF200FL models are installed on lifting rods so a single stack of cartridges are removed at one time for convenience.

Typical Installations:

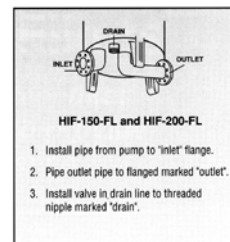
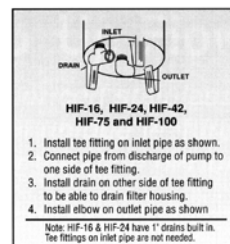
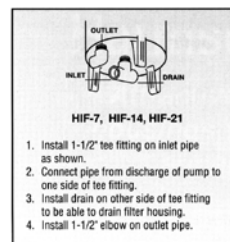

Specifications:

Filter Vessel & Metal components	Low carbon 304 stainless steel, electro polished
Rods & standpipes	CPVC, standard models; 304 stainless steel, all stainless models
Pipe caps	CPVC, standard models; 304 stainless steel, all stainless models
Rim gaskets	EPDM, standard. Buna-N and Viton available
O-Rings	Buna-N, standard. EPDM and Viton available
Bottom seals	Natural gum rubber, standard; EPDM and Buna-N available
Wing Nuts	Brass, Brass nuts and stainless steel flat washers available
Temperature	Rated to 140°F (60°C) with CPVC rods, pipe caps, stanf pipes & standard Harmsco cartridges. To 200°F (93°C) for all stainless models with stainless steel rods, pipe caps, standpipes and Harmsco High-temp cartridges. Temperature limits vary and depend on pressure & time under load.
Pressure	Rated for pressure to 150 psid(10 bar) maximum.
Flow	Typical flow rates are 3-6 GPM per single length 9 3/4" Harmsco cartridges.

Chemical Resistant Coatings:



Harmsco™ filters are available with a DYKOR coating, a high performance material like PTFE used to provide increased resistance to chemicals, abrasion & the environment. The coating is applied to all stainless steel surfaces (inside & out).

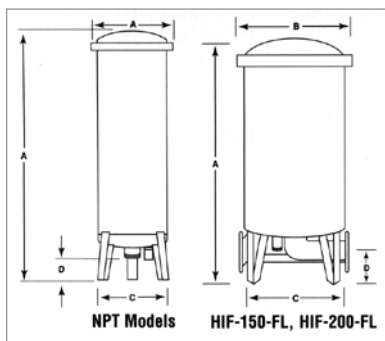

Model	A	B	C	D	Service Height	Inlet/Outlet	Drain
HIF7	19 1/2"	13"	13"	3 1/2"	35"	1 1/2" NPT	None*
HIF14	28"	13"	13"	3 1/2"	48"	1 1/2" NPT	None*
HIF16	28"	13"	13"	4"	48"	2" NPT	1" NPT
HIF21	37"	13"	13"	3 1/2"	68"	1 1/2" NPT	None*
HIF24	37"	13"	13"	4"	68"	2" NPT	1" NPT
HIF42	40"	18"	18"	5 3/8"	68"	2" NPT	None*
HIF75	42"	20"	20"	5 7/8"	70"	3" NPT	None*
HIF100	52"	20"	20"	5 7/8"	87"	3" NPT	None*
HIF150FL	48"	28"	28"	5 3/16"	76"	4" Flange	1 1/2" NPT
HIF200FL	58"	28"	28"	5 3/16"	93"	4" Flange	1 1/2" NPT

* Install tee fittings and valve on inlet for drain. ** To center of flange fittings.

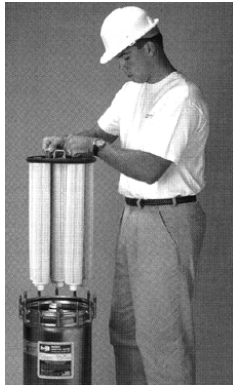
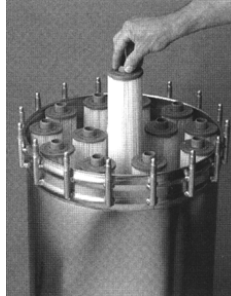
Cluster Models

High Capacity Models
**Harmsco™ Filters Features:
Cartridge Cluster Models:**

- Entire set of filter cartridges is removed at one time for cleaning or replacement.
- Filter rack assembly is made of CPVC (stainless steel available)
- Rugged 304 electro-polished stainless steel housing.
- Individual studs for safe, secure lid closure.
- Brass wing nuts for hand tightening.
- Pressure rated to 150 PSI.
- For whole house, commercial, industrial, municipal applications.

High Capacity Models:

- Same features as above with:
- CPVC lifing rods to remove a single stack of cartridges at one time.

HIF 7-100

Part Number	HIF7	HIF14	HIF16	HIF21	HIF24
Flow Rate (USGPM)	Up to 30	Up to 60	Up to 75	Up to 90	Up to 100
Flow Rate (LPM)	Up to 113	Up to 226	Up to 284	Up to 340	Up to 397
Flow Rate (M3HR)	Up to 7	Up to 14	Up to 16	Up to 21	Up to 24
# of Std Cartridges	7	14	16	21	24
Alternative cartridge	Single only	Doubles	Doubles	Triples	Triples
Pipe size	1 1/2" NPT	1 1/2" NPT	2" NPT	1 1/2" NPT	2" NPT
Filter Height	19.5"	28"	28"	37"	37"
Floor space required	13" x 13"	13" x 13"	13" x 13"	13" x 13"	13" x 13"
Service Height clearance	35"	48"	48"	68"	68"
Shipping weight	29 lbs.	39 lbs.	39 lbs.	50 lbs.	50 lbs.
Carton dimensions	14" x 14" x 21"	14" x 14" x 38"	14" x 14" x 38"	14" x 14" x 41"	14" x 14" x 41"

LIST PRICE	\$ 3922.28	5571.52	6082.28	7088.17	7591.15
------------	-------------------	----------------	----------------	----------------	----------------

*cartridges not included

HIF - FL Series

Part Number	HIF42	HIF75
Flow Rate (USGPM)	Up to 175	Up to 300
Flow Rate (LPM)	Up to 662	Up to 1135
Flow Rate (M3HR)	Up to 42	Up to 75
# of Std Cartridges	42	75
Alternative cartridge	Triples	Triples
Pipe size	2" NPT	3" NPT
Filter Height	40"	42"
Floor space required	18" x 18"	20" x 20"
Service Height clearance	68"	70"
Shipping weight	100 lbs.	129 lbs.
Carton dimensions	19" x 19" x 43"	23" x 23" x 53"

LIST PRICE	\$17146.60	23798.89
------------	-------------------	-----------------

*cartridges not included

Recommended flow rates for guidelines only. Typical flow rates are 3 to 6 GPM per 9 3/4" cartridge. Standard Harmsco Up-Flow filter housings and filter cartridges rated for temperatures to 140°F (60°C) ratings based on pressure and time under load. All stainless filter housings and high temperature cartridges recommended for temperature over 140°F (60°C) to 200°F (93°C).



HUR-AP Series

Harmsco™ Hurricane Filters

It's a Separator & Cartridge Filter in One

Hurricane filters provide unsurpassed performance because they separate dense solids prior to cartridge filtration for extended filter life, increased dirt holding capacity and reduced maintenance costs. In many respects Hurricane filters are two filters in one. Components include outer chamber for particle separation, inner chamber for cartridge filtration and built-in drain for purge, if required.

Features:

- Outer chamber collects heavy solids at the bottom due to centrifugal force & rotational flow.
- Inner chamber filters liquid through a single cartridge. Liquid enters the filter tangentially to provide rotational flow and centrifugal force for partial separation. Liquid flows out of the filter through the standpipe and outlet fitting.
- Rotational flow pattern continuously "fluffs" filter cake to increase dirt and debris holding capacity to extend filter life and time between cleaning.
- In heavy solid applications, manual or automatic valves may be used to purge solids from the outer chamber. Tests demonstrate approximately half of the heavy solids, like sand, separate prior to the filtration chamber at 50 GPM.
- Constructed of low carbon 3/4 stainless steel for durability and long life.
- All stainless steel components are electro-polished for superior finish, resistance to corrosion & increased durability. (Special chemical resistant coatings available.)
- Fail safe lids with individual studs for optimum security. No v-clamps with only one bolt to secure lids.
- Bronze wing nuts are used so no tools are required. Finger tight is generally sufficient. Hex nuts are recommended with 75 ft-lbs. of torque above 100 psi.
- 90° elbow and 45° sweep on outlet for staggered in-line installation.
- CPVC standpipe for up-flow design.
- 1/4" couplers are installed in inlet and outlet fittings for pressure gauges.

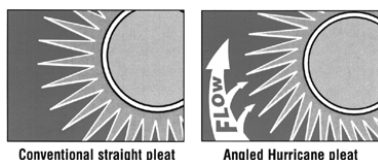

Unlike conventional designs, Hurricane's patented cartridges are made with deep, angles pleats to direct the flow into the pleated area for increased solids removal.



Single "Jumbo" Cartridge Filter

Design of a single, jumbo cartridge is easy to install, remove, clean and replace. Hurricane Cartridges are cleanable and re-usable in most applications.

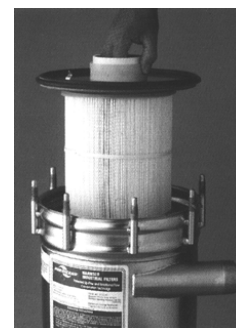

Part Number	HUR40HP	HUR90HP	HUR170HP
Flow Rate (USGPM)	Up to 50	Up to 100	Up to 150
Flow Rate (LPM)	Up to 189	Up to 378	Up to 568
Flow Rate (M3HR)	Up to 12	Up to 24	Up to 36
Pipe size (NPT)	2"	2"	2"
Drain (NPT)	1"	1"	1"
Filter Height	21"	31"	41"
Floor space required	15" x 15"	15" x 15"	15" x 15"
Service Height clearance	31"	51"	72"
Shipping weight	40 lbs.	51 lbs.	64 lbs.
LIST PRICE	\$ 7345.51	8737.44	13162.68

*cartridges not included



801 Series

Genuine Harmsco® Filter Cartridge Features:

- Heavy duty filter applications.
- Pleated polyester design for more surface area, longer life.
- **Six Sq Ft.** of filtration, 50% more than the competition per 9 3/4". (12 sq ft for 19 1/2")
- Thermally bonded construction with FDA listed materials.
- Color coded & branded end caps for easy micron identification.
- Cleanable, reusable in most applications.
- Low pressure drop.
- Individually wrapped.



Specifications:

Media:	Polyester-Plus™
End Caps:	Plastisol (pliable PVC)
Center tubes:	Rigid PVC perforated
Surface Area:	Approx 6 sq.ft. (9 3/4")
Temp limit:	Up to 140°F depending on time & load
pH:	3-11
Flow rate:	3-6 GPM per 9 3/4"
Dimensions:	2 3/4" OD, 1 1/16" ID



Certified to ANSI-NSF 61



Third Party Certified to NSF / ANSI 372

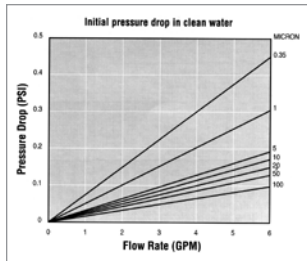

Part Number	Micron Size	Cap Color	OD	Length	Ctn Qty	List Price
801-0.35-W	0.35	Brown	2 3/4"	9 3/4"	24	\$ 58.06
801-1-W	1	Tan	2 3/4"	9 3/4"	24	43.56
801-5-W	5	White	2 3/4"	9 3/4"	24	36.57
801-10-W	10	Red	2 3/4"	9 3/4"	24	36.57
801-20-W	20	Blue	2 3/4"	9 3/4"	24	36.57
801-50-W	50	Yellow	2 3/4"	9 3/4"	24	36.57
801-100-W	100	Green	2 3/4"	9 3/4"	24	36.57
921-20-W	20	Blue	2 3/4"	19 1/2"	24	73.55



HB Series



Certified to ANSI-NSF 61



Third Party Certified to NSF / ANSI 372

Harmsco® Calypso Blue™ Filter Cartridge Features:

- Premium quality made of pleated polyester filter media for long life and high dirt holding.
- Cartridges can be cleaned and reused in most applications.
- Individually shrink wrapped.

Part Number	Micron Size	OD	Length	Ctn Qty	List Price
HB-10-0.35-W	0.35	4 1/2"	9 3/4"	8	\$ 135.49
HB-10-1-W	1	4 1/2"	9 3/4"	8	100.34
HB-10-5-W	5	4 1/2"	9 3/4"	8	88.32
HB-10-20-W	20	4 1/2"	9 3/4"	8	88.32
HB-10-50-W	50	4 1/2"	9 3/4"	8	88.32
HB-20-0.35-W	0.35	4 1/2"	20"	4	\$ 220.21
HB-20-1-W	1	4 1/2"	20"	4	177.93
HB-20-5-W	5	4 1/2"	20"	4	152.34
HB-20-20-W	20	4 1/2"	20"	4	152.34
HB-20-50-W	50	4 1/2"	20"	4	152.34



Certified to ANSI-NSF 61



Third Party Certified to NSF / ANSI 372

HAC10W

Genuine Harmsco® Activated Carbon Filter Cartridge Features:

- Composite of pulverized activated carbon & polyolefin fibers bonded together.
- 5 micron rating.
- Max temp 160°F.
- Substantially removes chlorine, organic chemicals, tastes and odors.
- Max capacity; 3000 gal.chlorine, 500 gal. organic chemicals.

Part Number	Micron Size	OD	Length	Ctn Qty	List Price
HAC10W	5	2 3/4"	9 3/4"	24	\$ 71.31

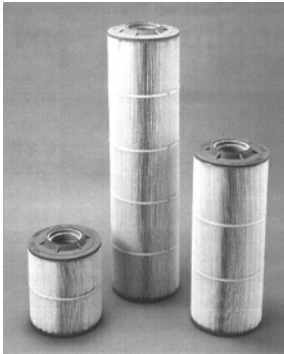

HC Series



Certified to
ANSI-NSF 61



NO LEAD
< 0.25% Pb by
weighted avg
Third Party Certified
to NSF / ANSI 372

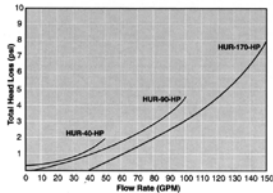

Pressure drop shown above is for filter housing and 20 micron filter cartridge in clean water. Data developed by NSF International.

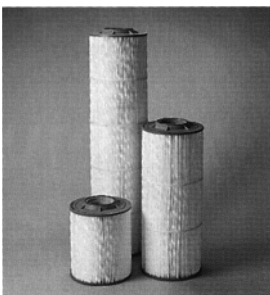

PP Series



Certified to
ANSI-NSF 61



NO LEAD
< 0.25% Pb by
weighted avg
Third Party Certified
to NSF / ANSI 372

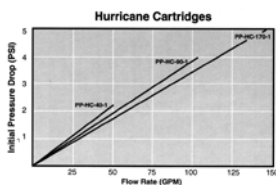

Data include cartridge and Hurricane filter housing.

Genuine Hurricane Replacement Cartridge Features:

- Standard pleated polyester filter elements.
- Polyester-Plus™ filter media is cleanable and reusable in most applications.
- Rated to 140°F and to 50 psi.
- Separates solids in liquids with pH of 3 to 11.
- Cartridge OD 7 3/4", ID 3" FPT
- Packaged one per carton.

Part Number	Micron Size	Length	Ctn Qty	List Price
HUR40HP Replacement Cartridges				
HC40-1	1	9 5/8"	1	\$ 450.21
HC40-5	5	9 5/8"	1	413.44
HC40-20	20	9 5/8"	1	413.44
HUR90HP Replacement Cartridges				
HC90-0.35	0.35	19 1/2"	1	711.98
HC90-5	5	19 1/2"	1	578.82
HC90-20	20	19 1/2"	1	578.82
HC90-50	50	19 1/2"	1	578.82
HC90-100	100	19 1/2"	1	578.82
HUR170HP Replacement Cartridges				
HC170-1	1	30 3/4"	1	987.65
HC170-5	5	30 3/4"	1	895.77
HC170-20	20	30 3/4"	1	895.77

Genuine Hurricane Poly-Pleat™ Replacement Cartridge Features:

- Designed for drinking water applications to remove **cryptosporidium** and **Giardia Cysts**.
- Rated to 140°F
- Polypropylene filter media offers compatability with many aggressive chemicals.
- PP-S Series Cartridges OD 2 3/4"
- PP-BB Series Cartridges OD 4 1/4"
- PPHC Series Cartridge OD 7 3/4", ID 3" FPT.
- Individually wrapped.

Part Number	Micron Size	Length	Ctn Qty	List Price
PP-S-1	1 absolute	9 3/4"	24	\$ 90.16
PP-BB-10-1	1 absolute	9 3/4"	8	208.20
PP-BB-20-1	1 absolute	19 1/2"	1	349.69
PPHC40-1	1 absolute	9 5/8"	1	787.46
PPHC90-1	1 absolute	19 1/2"	1	1246.85

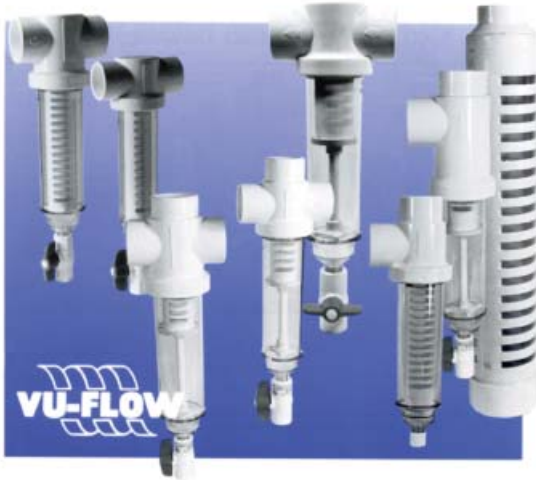
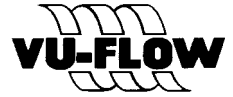

Vu-Flow Filter Features:

- Easy installation on suction or discharge side of pump.
- Filtered material collects on the outside of the screen, making it easy to clean.
- Clear polycarbonate housing permits instant visual inspection.
- Molded PVC filter body allows glue together installation similar to standard PVC pipe fittings.
- Molded from UV stabilized weather resistant materials for long service life.
- Most models have 1/2" MNPT cover drain outlet for quick one step purge cleaning.
- Inlet and outlet slip can be bushed to fit required pipe size.
- Polyester screens are easily cleaned and re-used eliminating expensive replacement.
- Stainless steel screens are available on some filters.
- Maximum operating pressure: 150 psi @ 73°F.
- Flow rates from 1-100 gallons per minute.
- Screen mesh sizes smaller than 250 (61 microns) are supported with No. 30 mesh to assure durability.

• WATER USE ONLY

EQUIVALENCY CHART

MESH	MICRONS	INCHES
24	711	0.028
* 30	533	0.021
40	381	0.015
* 60	254	0.010
* 100	152	0.006
* 140	104	0.004
250	61	0.0024
500	30	0.0012
1000	15	0.0006

* Also available with stainless steel by special order

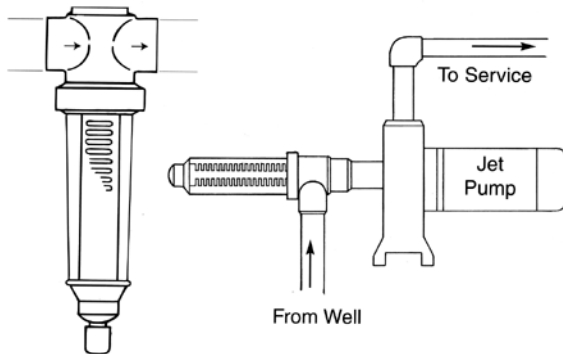

INSTALLATION

- Install on suction or discharge side of system.
- Install on discharge to allow use of purge valve for easy one step purge cleaning. * Do not install filters with purge valves on suction side of pump.
- Manifold two or more filters for applications with flow rates higher than 100 GPM.
- Hand tighten only - Use of tools voids warranty



CF Series



Combination Style Screen Filter Features:

- Installs as a 90° "L" or 180° in-line "T" installation.
- 10-100 GPM models.
- 1-1/4" plug (supplied) adds versatility to unused outlet.
- Maximum pressure: 150 PSI @ 73°F.
- 1/2" MPT drain cleanout with purge valve.
- Supplied with polyester filter screens.

- **WATER USE ONLY**

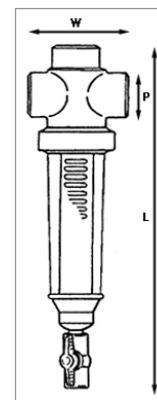
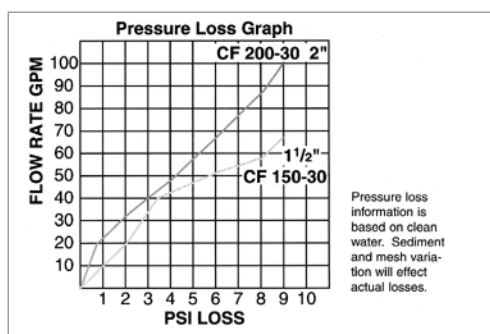

Part Number	Inlet/Outlet "P" Slip x Slip x Slip	Mesh # Size	Mesh # Opening	Min*/Max Flow GPM	"L"	"W"	List Price w/ Purge Valve
CF150-24P	1 1/2"	24 (711 mic)	0.028	10-50	16 5/8"	5 1/4"	\$ 163.63
CF150-40P	1 1/2"	40 (381 mic)	0.015	10-50	16 5/8"	5 1/4"	163.63
CF150-60P	1 1/2"	60 (254 mic)	0.0100	10-50	16 5/8"	5 1/4"	172.01
CF150-100P	1 1/2"	100 (152 mic)	0.006	10-50	16 5/8"	5 1/4"	172.01
CF150-140P	1 1/2"	140 (104 mic)	0.004	10-50	16 5/8"	5 1/4"	172.01
CF150-250P	1 1/2"	250 (61 mic)	0.0024	10-50	16 5/8"	5 1/4"	176.91
CF150-500P	1 1/2"	500 (30 mic)	0.0012	10-50	16 5/8"	5 1/4"	176.91
CF150-1000P	1 1/2"	1000 (15 mic)	0.0006	10-50	16 5/8"	5 1/4"	176.91
CF200-24P	2"	24 (711 mic)	0.028	18-100	18 7/8"	5 1/2"	266.30
CF200-40P	2"	40 (381 mic)	0.015	18-100	18 7/8"	5 1/2"	266.30
CF200-60P	2"	60 (254 mic)	0.0100	18-100	18 7/8"	5 1/2"	273.23
CF200-100P	2"	100 (152 mic)	0.006	18-100	18 7/8"	5 1/2"	273.23
CF200-140P	2"	140 (104 mic)	0.004	18-100	18 7/8"	5 1/2"	273.23
CF200-250P	2"	250 (61 mic)	0.0024	18-100	18 7/8"	5 1/2"	282.94
CF200-500P	2"	500 (30 mic)	0.0012	18-100	18 7/8"	5 1/2"	282.94

- Do not use metal valve or fitting on 1/2" drain connection.
- Do not install filters with purge valve on suction side of pump.
- * Minimum flow needed for "spin-out" action.

Carton Quantity of 10 for all products



NT Series

T Style Screen Filter Features:

- 180° in-line "T" style installation.
- 1-100 GPM models.
- 1/2" MPT cleanout with purge valve.
- Supplied with polyester filter screens.
- **WATER USE ONLY**

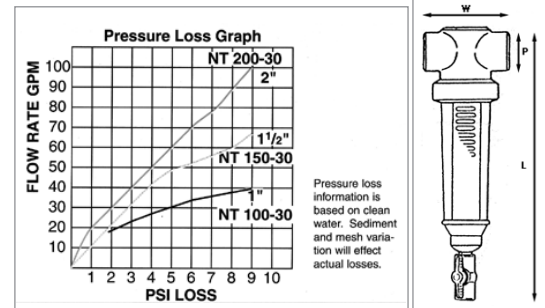
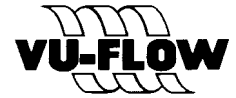

Part Number	Inlet/Outlet "P"	Mesh # Size	Mesh Opening	Min*/Max Flow GPM	"L"	"W"	List Price
IPS x IPS							
NT75-24P	3/4" x 3/4"	24 (711 mic)	0.028	1-25	11 3/8"	5"	\$ 113.41
NT75-60P	3/4" x 3/4"	60 (254 mic)	0.010	1-25	11 3/8"	5"	113.80
NT75-100P	3/4" x 3/4"	100 (152 mic)	0.006	1-25	11 3/8"	5"	113.80
NT75-140P	3/4" x 3/4"	140 (104 mic)	0.004	1-25	11 3/8"	5"	113.80
NT75-250P	3/4" x 3/4"	250 (61 mic)	0.0024	1-25	11 3/8"	5"	118.00
NT75-500P	3/4" x 3/4"	500 (30 mic)	0.0012	1-25	11 3/8"	5"	118.00
NT75-1000P	3/4" x 3/4"	1000 (15 mic)	0.0006	1-25	11 3/8"	5"	118.00
Slip x Slip							
NT100-24P	1" x 1"	24 (711 mic)	0.028	1-25	11 3/8"	5"	81.18
NT100-30P	1" x 1"	30 (533 mic)	0.021	1-25	11 3/8"	5"	81.18
NT100-40P	1" x 1"	40 (381 mic)	0.015	1-25	11 3/8"	5"	81.18
NT100-60P	1" x 1"	60 (254 mic)	0.01	1-25	11 3/8"	5"	81.18
NT100-100P	1" x 1"	100 (152 mic)	0.006	1-25	11 3/8"	5"	81.01
NT100-140P	1" x 1"	140 (104 mic)	0.004	1-25	11 3/8"	5"	83.57
NT100-250P	1" x 1"	250 (61 mic)	0.0024	1-25	11 3/8"	5"	84.32
NT100-500P	1" x 1"	500 (30 mic)	0.0012	1-25	11 3/8"	5"	86.19
NT100-1000P	1" x 1"	1000 (15 mic)	0.0006	1-25	11 3/8"	5"	93.25
Slip x Slip							
NT150-24P	1-1/2" x 1-1/2"	24 (711 mic)	0.028	10-50	15 3/8"	5 1/4"	146.50
NT150-30P	1-1/2" x 1-1/2"	30 (533 mic)	0.021	10-50	15 3/8"	5 1/4"	146.50
NT150-40P	1-1/2" x 1-1/2"	40 (384 mic)	0.015	10-50	15 3/8"	5 1/4"	146.50
NT150-60P	1-1/2" x 1-1/2"	60 (254 mic)	0.010	10-50	15 3/8"	5 1/4"	150.37
NT150-100P	1-1/2" x 1-1/2"	100 (152 mic)	0.006	10-50	15 3/8"	5 1/4"	150.37
NT150-140P	1-1/2" x 1-1/2"	140 (104 mic)	0.004	10-50	15 3/8"	5 1/4"	150.37
NT150-250P	1-1/2" x 1-1/2"	250 (61 mic)	0.0024	10-50	15 3/8"	5 1/4"	156.72
NT150-500P	1-1/2" x 1-1/2"	500 (30 mic)	0.0012	10-50	15 3/8"	5 1/4"	159.77
NT150-1000P	1-1/2" x 1-1/2"	1000 (15 mic)	0.0006	10-50	15 3/8"	5 1/4"	159.77
Slip x Slip							
NT200-24P	2" x 2"	24 (711 mic)	0.028	18-100	17 7/8"	5 1/2"	230.82
NT200-30P	2" x 2"	30 (533 mic)	0.021	18-100	17 7/8"	5 1/2"	231.74
NT200-40P	2" x 2"	40 (384 mic)	0.015	18-100	17 7/8"	5 1/2"	231.74
NT200-60P	2" x 2"	60 (254 mic)	0.010	18-100	17 7/8"	5 1/2"	239.40
NT200-100P	2" x 2"	100 (152 mic)	0.006	18-100	17 7/8"	5 1/2"	239.40
NT200-140P	2" x 2"	140 (104 mic)	0.004	18-100	17 7/8"	5 1/2"	239.40
NT200-250P	2" x 2"	250 (61 mic)	0.0024	18-100	17 7/8"	5 1/2"	246.28
NT200-500P	2" x 2"	500 (30 mic)	0.0012	18-100	17 7/8"	5 1/2"	246.28
NT200-1000P	2" x 2"	1000 (15 mic)	0.0006	18-100	17 7/8"	5 1/2"	246.28

* Minimum flow needed for "spin-out" action.

• Do not install filters with purge valve on suction side of pump.

Carton Quantity of 10 for all products



NT SO Series



T Style Sand Separator Filter Features:

- 180° in-line "T" style.
- 1-100 GPM models
- "Spin-out" action separates heavier than water particles away from screen into the collection chamber.
- Screen portion of element removes lighter than water particles.
- Extended sump provides greater collection area for sediment.
- Supplied with a 1/2" cleanout with purge valve.
- Supplied with polyester filter screens.

• WATER USE ONLY

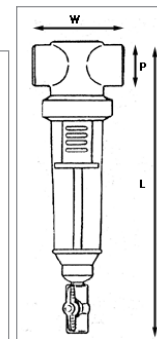
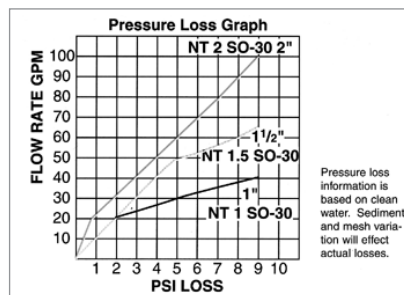

Part Number	Inlet/Outlet "P"	Mesh # Size	Mesh Opening	Min*/Max Flow GPM	"L"	"W"	List Price w/ Purge Valve
IPS x IPS (Female Thread 3/4" only)							
NT75SO-60P	3/4" x 3/4"	60 (254 mic)	0.01	1-25	14 3/8"	5	\$ 148.41
NT75SO-100P	3/4" x 3/4"	100 (152 mic)	0.006	1-25	14 3/8"	5	148.41
NT75SO-140P	3/4" x 3/4"	140 (104 mic)	0.004	1-25	14 3/8"	5	148.41
NT75SO-250P	3/4" x 3/4"	250 (61 mic)	0.0024	1-25	14 3/8"	5	153.93
Slip x Slip							
NT1SO-60P	1" x 1"	60 (254 mic)	0.01	1-25	14 3/8"	5	148.41
NT1SO-100P	1" x 1"	100 (254 mic)	0.006	1-25	14 3/8"	5	148.41
NT1SO-140P	1" x 1"	140 (104 mic)	0.004	1-25	14 3/8"	5	148.41
NT1SO-250P	1" x 1"	250 (61 mic)	0.0024	1-25	14 3/8"	5	153.93
Slip x Slip							
NT1.5SO-24P	1-1/2" x 1-1/2"	24 (711 mic)	0.028	10-50	15 3/8"	5 1/4"	180.30
NT1.5SO-30P	1-1/2" x 1-1/2"	30 (533 mic)	0.021	10-50	15 3/8"	5 1/4"	180.30
NT1.5SO-40P	1-1/2" x 1-1/2"	40 (384 mic)	0.015	10-50	15 3/8"	5 1/4"	180.30
NT1.5SO-60P	1-1/2" x 1-1/2"	60 (254 mic)	0.010	10-50	15 3/8"	5 1/4"	185.77
NT1.5SO-100P	1-1/2" x 1-1/2"	100 (152 mic)	0.006	10-50	15 3/8"	5 1/4"	185.77
NT1.5SO-140P	1-1/2" x 1-1/2"	140 (104 mic)	0.004	10-50	15 3/8"	5 1/4"	185.77
NT1.5SO-250P	1-1/2" x 1-1/2"	250 (61 mic)	0.0024	10-50	15 3/8"	5 1/4"	192.87
NT1.5SO-500P	1-1/2" x 1-1/2"	500 (30 mic)	0.0012	10-50	15 3/8"	5 1/4"	192.87
Slip x Slip							
NT2SO-24P	2" x 2"	24 (711 mic)	0.028	18-100	17 7/8"	5 1/2"	271.12
NT2SO-30P	2" x 2"	30 (533 mic)	0.021	18-100	17 7/8"	5 1/2"	271.12
NT2SO-40P	2" x 2"	40 (384 mic)	0.015	18-100	17 7/8"	5 1/2"	271.12
NT2SO-60P	2" x 2"	60 (254 mic)	0.010	18-100	17 7/8"	5 1/2"	275.77
NT2SO-100P	2" x 2"	100 (152 mic)	0.006	18-100	17 7/8"	5 1/2"	275.77
NT2SO-140P	2" x 2"	140 (104 mic)	0.004	18-100	17 7/8"	5 1/2"	275.77
NT2SO-250P	2" x 2"	250 (61 mic)	0.0024	18-100	17 7/8"	5 1/2"	282.55
NT2SO-500P	2" x 2"	500 (30 mic)	0.0012	18-100	17 7/8"	5 1/2"	282.55

*Do not use metal valve or fitting on 1/2" drain connections

• Do not install filters with purge valves on the suction side of pump

* Minimum flow needed for "spin-out" action.

Carton Quantity of 10 for all products



L Series



L Style Screen Filter Features:

- 90° "L" style installation.
- Install on suction or discharge side of pump.
- 0-100 GPM models.
- 1/2" MPT drain cleanout is not available on this model.
- Maximum pressure: 150 PSI @ 73°F.
- Supplied with polyester filter screens.

- **WATER USE ONLY**

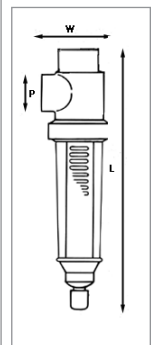
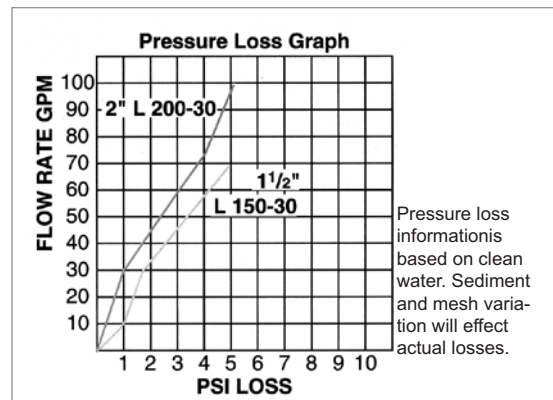

Part Number	Inlet/Outlet "P" Slip	Mesh # Size	Mesh Opening	Normal Flow GPM	"L"	"W"	List Price
L150-24	1-1/2" x 1-1/2"	24 (711 mic)	0.028	0-50	14 1/4	4-1/2	155.35
L150-30	1-1/2" x 1-1/2"	30 (533 mic)	0.021	0-50	14 1/4	4-1/2	155.35
L150-60	1-1/2" x 1-1/2"	60 (254 mic)	0.010	0-50	14 1/4	4-1/2	161.60
L150-100	1-1/2" x 1-1/2"	100 (152 mic)	0.006	0-50	14 1/4	4-1/2	161.60
L150-250	1-1/2" x 1-1/2"	250 (61 mic)	0.0024	0-50	14 1/4	4-1/2	167.94
L150-500	1-1/2" x 1-1/2"	500 (30 mic)	0.0012	0-50	14 1/4	4-1/2	167.94
L200-24	2" x 2"	24 (711 mic)	0.028	0-100	18	5 1/2"	253.85
L200-30	2" x 2"	30 (533 mic)	0.021	0-100	18	5 1/2"	253.85
L200-60	2" x 2"	60 (254 mic)	0.010	0-100	18	5 1/2"	261.40
L200-100	2" x 2"	100 (152 mic)	0.006	0-100	18	5 1/2"	261.40
L200-250	2" x 2"	250 (61 mic)	0.0024	0-100	18	5 1/2"	270.49
L200-500	2" x 2"	500 (30 mic)	0.0012	0-100	18	5 1/2"	270.49

"L" Style filters do not use purge valves.

Carton Quantity of 10 for all products



L SO Series



L Style Sand Separator Filter Features:

- 90° "L" style installation.
 - "Spin out action" separates heavier than water particles away from the screen into the collection chamber.
 - 5-90 GPM
 - Screen portion of element removes lighter than water elements.
 - Available in 5-20, 15-40 and 5-90 GPM models.(A minimum flow rate of 5 GPM is required to operate the filter).
 - Extended sump provides greater collection area for sediment.
 - 1/2" MPT cleanout with purge valve.
 - Supplied with polyester filter screens.
 - Available in Low Flow(LF) or High Flow(HF) models.
- **WATER USE ONLY**

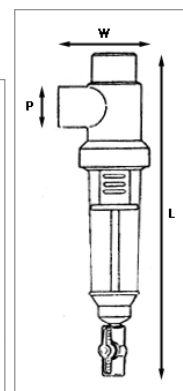
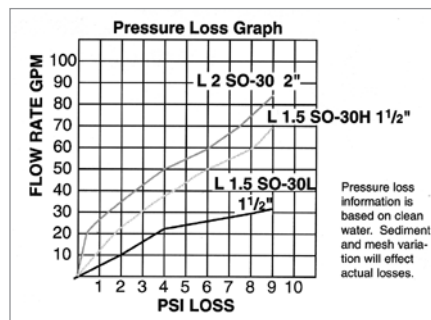

Part Number	Inlet/Outlet Slip x Slip "P"	Mesh # Size	Mesh Opening	Min*/Max GPM	"L"	"W"	List Price w/ Purge Valve
L1.5SO-60LFP	1-1/2"	60 (254 mic)	0.01	5-20	14 7/8"	4-1/2	\$ 194.91
L1.5SO-60HFP	1-1/2"	60 (254 mic)	0.01	15-40	14 7/8"	4-1/2	194.91
L1.5SO-100LFP	1-1/2"	100 (152 mic)	0.006	5-20	14 7/8"	4-1/2	194.91
L1.5SO-100HFP	1-1/2"	100 (152 mic)	0.006	15-40	14 7/8"	4-1/2	194.91
L1.5SO-140LFP	1-1/2"	140 (104 mic)	0.004	5-20	14 7/8"	4-1/2	194.91
L1.5SO-140HFP	1-1/2"	140 (104 mic)	0.004	15-40	14 7/8"	4-1/2	194.91
L1.5SO-250LFP	1-1/2"	250 (61 mic)	0.0024	5-20	14 7/8"	4-1/2	202.55
L1.5SO-250HFP	1-1/2"	250 (61 mic)	0.0024	15-40	14 7/8"	4-1/2	202.55
L1.5SO-500HFP	1-1/2"	500 (30 mic)	0.0012	15-40	14 7/8"	4-1/2	202.55
L2SO-60P	2"	60 (254 mic)	0.01	35-90	20 7/8"	5-1/2	289.19
L2SO-100P	2"	100 (152 mic)	0.006	35-90	20 7/8"	5-1/2	289.19
L2SO-140P	2"	140 (104 mic)	0.004	35-90	20 7/8"	5-1/2	289.19
L2SO-250P	2"	250 (61 mic)	0.0024	35-90	20 7/8"	5-1/2	296.74

- Do not use metal valve or fitting on 1/2" drain connection
- Do not install filters with purge valves on the suction side of pump
- LF suffix denotes low flow, HF suffix demotes high flow.
- * Minimum flow needed for "spin-out" action.

Carton Quantity of 10 for all products

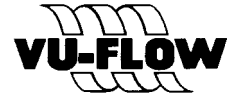

REPLACEMENT SCREENS FOR FILTERS



NT Screen L	L	OD
NT30	5 1/8	1 1/8
NT60	8 1/8	1 5/8
NT120	10	1 7/8

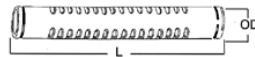

L Screen L	L	OD
L60	9 7/8	1 5/8
L120	14 7/8	1 7/8

3/4" & 1" NT Filters

Part No.	List Price
NT30SC24	\$ 26.32
NT30SC30	26.32
NT30SC40	26.32
NT30SC60	27.02
NT30SC100	27.02
NT30SC140	27.02
NT30SC250	30.51
NT30SC500	30.51
NT30SC1000	30.51

1-1/2" NT or Combo Filters

Part No.	List Price
NT60SC24	\$ 43.21
NT60SC30	43.21
NT60SC40	43.21
NT60SC60	47.29
NT60SC100	47.29
NT60SC140	47.29
NT60SC250	52.76
NT60SC500	52.76
NT60SC1000	52.76

2" NT or Combo Filters

Part No.	List Price
NT120SC24	\$ 72.80
NT120SC30	72.80
NT120SC40	72.80
NT120SC60	78.15
NT120SC100	78.15
NT120SC140	78.15
NT120SC250	86.43
NT120SC500	86.43
NT120SC1000	86.43

1-1/2" L Filters

Part No.	List Price
L60SC24	\$ 45.29
L60SC30	45.29
L60SC40	45.29
L60SC60	49.97
L60SC100	49.97
L60SC140	49.97
L60SC250	54.63
L60SC500	54.63
L60SC1000	54.63

2" L Filters

Part No.	List Price
L120SC24	\$ 75.60
L120SC30	75.60
L120SC40	75.60
L120SC60	81.66
L120SC100	81.66
L120SC140	81.66
L120SC1000	90.38

REPLACEMENT SCREENS FOR SAND SEPARATORS



NT Sep Scrn L	L	OD
NT1SC	5 1/4	1 1/8

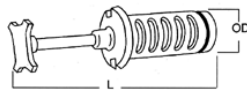

NT Sep Scrn L	L	OD
NT1.5SC	8 1/8	1 5/8
NT2SC	10	1 7/8



L Sep Scrn L	L	OD
L1.5SC	10	1 5/8
L2SC	13 3/4	1 7/8

3/4" & 1" NT Sand Separators

Part No.	List Price
NT1SC24	\$ 30.51
NT1SC30	30.51
NT1SC40	30.51
NT1SC60	31.80
NT1SC100	31.80
NT1SC140	31.80
NT1SC250	33.77
NT1SC500	33.77
NT1SC1000	33.77

1-1/2" NT Sand Separators

Part No.	List Price
NT1.5SC24	\$ 75.45
NT1.5SC30	75.45
NT1.5SC40	75.45
NT1.5SC60	77.00
NT1.5SC100	77.00
NT1.5SC140	77.00
NT1.5SC250	80.26
NT1.5SC500	80.26
NT1.5SC1000	80.26

2" NT Sand Separators

Part No.	List Price
NT2SC24	\$ 105.16
NT2SC30	105.16
NT2SC40	105.16
NT2SC60	107.85
NT2SC100	107.85
NT2SC140	107.85
NT2SC250	112.03
NT2SC500	112.03
NT2SC1000	112.03

1-1/2" L Sand Separators

Part No.	List Price
L1.5SC30	79.66
L1.5SC40	79.66
L1.5SC60	80.26
L1.5SC100	80.26
L1.5SC140	80.26
L1.5SC250	83.74
L1.5SC500	83.74
L1.5SC1000	83.74

2" L Sand Separators

Part No.	List Price
L2SC24	\$ 109.93
L2SC30	109.93
L2SC60	112.63
L2SC100	112.63
L2SC140	112.63
L2SC250	132.55
L2SC500	132.55

Basket Strainer Features:

- Intake screen for lakes or ponds
- High volume capacity, up to 100 GPM.
- Three mesh sizes.
- All PVC construction with easy clean nylon screen.
- Debris accumulates on outside of strainer screen.
- 2" IPS female inlet slip fittings.



4BSK Series



Part Number	Description	Ctn Qty	List Price
-------------	-------------	---------	------------

Basket Strainers

4BSK24	2"x 4"x 24", 24 Mesh Nylon Screen	10	\$ 120.77
4BSK60	2"x 4"x 24", 60 Mesh Nylon Screen	10	125.57
4BSK100	2"x 4"x 24", 100 Mesh Nylon Screen	10	130.35
4BSK250	2"x 4"x 24", 250 Mesh Nylon Screen	10	135.22

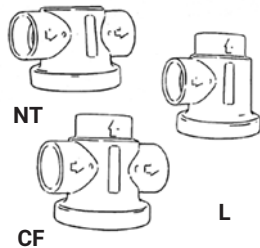

Filter Bodies (HEADS)

NT30B	1" NT Screen & NT Separator	1	51.56
NT60B	1-1/2" NT Screen & NT Separator	1	69.80
NT120B	2" NT Screen & NT Separator	1	84.79
CF60B	1-1/2" Combo Screen & Separator	1	83.54
CF120B	2" Combo Screen & Separator	1	105.73
L60B	1-1/2" L Screen	1	72.93
L120B	2" L Screen	1	89.28
L2B	2" L Separator	1	99.64



Screen Filter Covers (CLEAR SUMPS)

NT30C	1" & 3/4" NT & Combo Style	1	52.12
NT60C	1-1/2" NT & Combo Style	1	78.23
NT120C	2" NT & Combo Style - CLEAR	1	93.89
NT120W	2" NT & Combo Style - WHITE	1	97.03

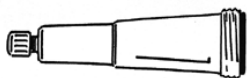

Separator Filter Covers (CLEAR SUMPS)

NT1C	1" NT, Combo & L Style	1	72.39
------	------------------------	---	-------

"O" Ring Kits Separator & Screen Filter

NT30S	1" & 3/4" NT & Combo Style	1	4.88
NT60S	1-1/2" NT & Combo Style	1	5.62
NT120S	2" NT & Combo Style	1	6.26
L60S	1-1/2" L Style	1	5.62
L120S	2" L Style	1	6.26

Cover Guard

CG100	Black Filter Protector, 1"	1	11.82
CG150	Black Filter Protector, 1-1/2"	1	15.66
CG200	Black Filter Protector, 2"	1	18.23

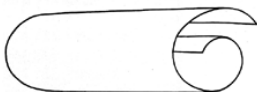



AFV Series

Automatic Flush Valve Kit Includes:

- (2) 1/2" barb x 1/2" NPT male hose fittings
- (2) SAE size 8 SS worm drive clamps
- (24") 1/2" braid reinforced flexible PVC tubing. (Rated at 215 psi)

KIT DOES NOT INCLUDE FILTER OR AUTOMATIC FLUSH VALVE.

Automatic Flush Valve Specifications:

- | | |
|---|------------------------|
| • Adjustable cycle time | 5 min - 24 hours |
| • Working Pressure | 200 PSIG |
| • Ambient Temperature | 25°F to 165°F |
| • Enclosure | Nema 4 |
| • Voltage | 115V, 1 Phase, 60 Hz |
| • Current | 2.5 Amps |
| • Valve Construction | Brass |
| • Seals | Reinforced PTFE |
| • Discharge Volume
(Gal per cycle @ 30 PSIG) | 1/2" NPT-.92 |
| • Power Cord | 8' heavy duty grounded |
| • Full Port Ball Valve | 1/2" NPT |
| • Discharge Time
(Non-adjustable) | 3.5 seconds |

Please Note: TO insure optimum performance of automatic flush valve, it is recommended that you use the above rated tubing only.

Part Number	Description	Ctn Qty	List Price
AFV	Automatic Flush Valve	1	\$ 896.72
AFV-KIT	Automatic Flush Valve Kit	1	52.83

Warranty and Disclaimer

A one year warranty applies to the original purchaser. The manufacturer warrants that the AFV will be free from original defects in material and workmanship.

Manufacturer will **repair or replace** all parts without charge, found to be defective under normal use and service within the warranty period upon return of product at customer's expense.



Ultraviolet disinfection is an effective way to provide bacteria free water for home or industry.



UVSL Series

- Completely automatic.
- Compact and easy to install.
- No chemicals required.
- Low operating costs.
- Low maintenance.
- No taste or odor.

SAFE LITE Economy Series UV Disinfection System Features:

- Quick installation.
- Economical.
- 304 stainless steel chamber. Electropolished.
- Sight port to safely view operation.
- 8 gallon complete with flow control.



UV, UVGDS & UV-W Series

Standard Series UV Disinfection System Features:

UV Series:

- Constructed for wall mounting.
- 304 stainless steel chamber. Electropolished.
- Sight port to safely view operation.
- 7 & 15 gallon complete with flow control.

UV-W Series:

- Same as UV series with:
- Internal wiper unit for manual cleaning of quartz sleeve.
- 8 & 15 gallon complete with flow control.

UV-GDS Series:

- Same as UV series with:
- 7 & 15 gallon complete with flow control. Remote flow control adder for 24 gallon (not included)
- Electronic built-in "lamp-out" circuit/alarm.
- ON/OFF indicator light.
- Standard auxillary output terminal for optional solenoid shut-off (UVS077 not included).
- Built in surge protector and fuse.



Water entering the disinfection unit flows in the space between the quartz sleeve and the chamber wall. Turbulent flow through the unit insures exposure of micro-organisms to lethal dosages of ultraviolet rays. Water exiting the chamber is safe and ready to use.

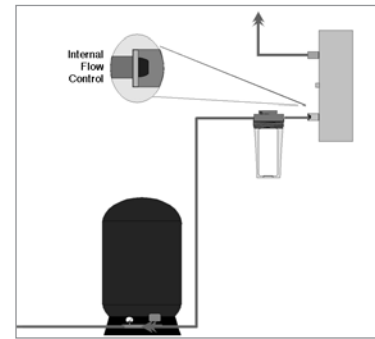
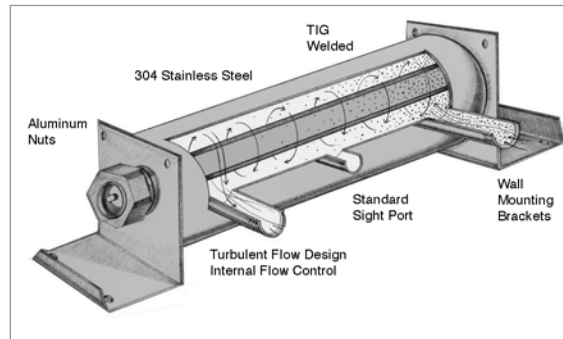

Typical Installation

Part Number	Supplier Part #	Max GPM	# of Lamps	KW @ 120V	AMPS @ 120V 220V	Pipe Size	Dimensions LxWxD	Weight	Lamp Out Alarm	List Price
-------------	-----------------	---------	------------	-----------	------------------	-----------	------------------	--------	----------------	------------

Safe Lite Economy Series

UVSL8		8	1	0.07	.60 .30	1" MIP 3/4" FIP	18"x4"x7"	8.5	No	\$ 1162.70
-------	--	---	---	------	---------	-----------------	-----------	-----	----	------------

Standard Series

UV7		7	1	0.07	.60 .30	1" MIP 3/4" FIP	18"x4"x7"	17	No	1343.90
UV15		15	1	0.07	.60 .30	1" MIP 3/4" FIP	36"x4"x7"	28	No	1684.42

GDS Series w/ Lamp out alarm

UV7SE	UV7GDS	7	1	0.07	.60 .30	1" MIP 3/4" FIP	18"x4"x7"	17	Yes	1535.81
UV15SE	UV15GDS	15	1	0.07	.60 .30	1" MIP 3/4" FIP	36"x4"x7"	28	Yes	1815.81

Lamp out circuit board provides a visual and audible alarm when a lamp outage occurs.

Solenoid protection can be added via the on-board relay and the purchase of an UVS079 Solenoid. 220V 50Hz less power cord net adder \$ 35.72. Not available on SE series.



UVM254



UVS079

Part Number	Description	For Use With Series	List Price
Accessories			
UVM254	UV Dosage meter w/ alarm	UV, UV-W	\$ 3353.47
UVS079	Shut-Off Solenoid 1" FNPT, use w/ UVM254, UV, UV-W, or UVM257 Specify when ordering	UV-SE, UVC	372.36

Part Number	Description	For Use With Series	List Price
Maintenance & Repair Parts			
UVP4025	Brass end nut assembly - complete (new)	All models	\$ 106.86
UVP8544	O-ring - Standard for end nut		4.79
UVP1421DWS7	Ballast	UV7	156.52
UVP1421SL8	Ballast	UVSL8	156.52
UVP8222	Ballast - (120V, 60 Hz)	UV7SE	156.52
UVP8224	Ballast - (120V, 60Hz)	UV15SE	156.52
UVP8225	Ballast - (120V, 60Hz)	UV15C	206.42

Service Kits - Include bulb, quartz sleeve, o-rings and small tube of silicone.

Recommended 1 per year.

UVK07	Includes (1) UVB1805 bulb, (1) UVQS6211 sleeve, (2) UVP8544 o-rings	UV7, UV7SE	212.70
UVK08	Includes (1) UVB4450 bulb, (1) UVQS476D sleeve, (1) UVP8544 o-ring	UVSL8	249.38
UVK015	Includes (1) UVB8246 bulb, (1) UVQS6608 sleeve, (2) UVP8544 o-rings	All 15 models	249.38
UVK024	Includes (2) UVB8246 bulb, (2) UVQS6608 sleeve, (4) UVP8544 o-rings	All 24 models	482.79

Part Number	Bulb Length	Description	For Use With Series	List Price
-------------	-------------	-------------	---------------------	------------

UV Bulbs

UVB1805	14"	1 pin each end	UV7, UV7SE	\$ 159.91
UVB1814	27.3"	1 pin each end		162.21
UVB8246	32.5"	1 pin each end	All 15 UVC80 24 28 60 120	162.21
UVB11149	45.88"	1 pin each end		162.21
UVB11550	61.2"	1 pin each end	UVC130 bulb	234.61

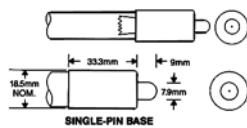

UVB Series - 1 pin each end

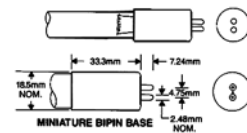

UVB Series - 2 pins each end

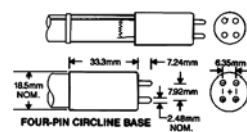

UVB Series - 4 pins one end

UVB2436	17"	2 pins each end		162.21
UVB2457	18"	2 pins each end	DWSW-8	162.21
UVB2793	31.34"	2 pins each end		162.21

UVB4287	11.3"	4 pins one end		162.21
UVB4330	13"	4 pins one end		162.21
UVB4357	14.5"	4 pins one end		162.21
UVB4409	16"	4 pins one end		162.21
UVB4436	17"	4 pins one end		162.21
UVB4450	17.71"	4 pins one end	DWS-8V, SE8V, SL5, SL8, SL8V	162.21

UVB4739	29"	4 pins one end	DWS-12V, SE12V	162.21
UVB4793	31.34"	4 pins one end		162.21
UVB4810	32"	4 pins one end		162.21
UVB4854	33.2"	4 pins one end		162.21

Bulb length is from end to end excluding pin connection.



UVQS Series



UVQS-D Series

Quartz Sleeves - Open Ends (22 mm ID, 24.5mm OD)

UVQS6211	14.37"	Quartz Sleeve	UV7, UV7SE	71.20
UVQS1483	19"	Quartz Sleeve	DWSW-8	105.69
UVQS6608	32.62"	Quartz Sleeve	All 12 15 24 48 60 80 120	105.69

Quartz Sleeves - Domed Ends (22 mm ID, 24.5mm OD)

UVQS1435D	17"	Dome End Quartz Sleeve		105.69
UVQS476D	19"	Dome End Quartz Sleeve	SL5, SL8, DWS-8V	105.69
UVQS335D	34"	Dome End Quartz Sleeve		105.69





Chem Tech Series 100

CHEM-TECH Series 100 Features:

- Positive displacement diaphragm metering pump.
- Feed ranges of 15 and 30 gallons per day.
- Operating pressure up to 100 PSI.
- Life-time lubricated, sealed and self-maintaining gear train.
- Four ball valve design for trouble-free operation.
- Strong chemical resistant, flame retardant housing.
- Metal reinforced, short-stroke diaphragm for extra-long life.
- Injection back pressure valve assembly enables injection at an angle and inhibits syphoning.
- Fully adjustable output capacity over operating range.
- Bleed valve assembly aids in priming and relieves pressure from discharge.
- UL, CSA approved for outdoor and indoor applications.
- Manufactured for AGI in an ISO9002 facility.



ISO 9002

CHEM-TECH Motorized Models:

Includes tubing and suction & discharge fittings

Part Number	Series	Max	Output capacity	Volts	Strokes/ Min.	OD	Ctn Qty	List Price
		Pressure PSI	@ Max psi GPD			Tube Size		
015-115	100	100	15	115	25	1/2"	1	\$ 1262.83
015-230	100	100	15	230	25	1/2"	1	1313.83
030-115	100	100	30	115	51	1/2"	1	1262.83
030-230	100	100	30	230	51	1/2"	1	1313.83

Additional ChemTech models are available, please contact your sales representative.



Chem Tech Series 100



Chem Tech Series 200



ISO 9002

Stocked* Parts for Series 100 and Series 200 CHEMTECH Pumps

NEW	OLD		
Part Number	Part Number	Description	List Price
25704	228P	Hypalon Diaphragm	\$ 165.38
28800	242P	SAN Head	181.20
J20560	278P	Ceramic Ball Check	23.04
J27903	237P	PTFE Gasket	23.04
J30515	J30515	PVC Bleed Valve Kit w/Tubing, 1/2" OD	267.22
J37440	638P	Hypalon Valve Seat	16.82
J38985	285P	Valve Spring	23.04
J40117	A50P	Foot Valve and Strainer Assembly, 1/2" OD	165.79
J41658	A52P	PVC Back Check Valve Assembly, 1/2" OD	202.13
J41694	J41694	1 1/2" long PVC Injection Ftg 1/2" OD tube size	294.05

* Other Series 100 & 200 parts may be ordered. Contact your sales representative.



Kop Kit®

KOP Kit® for Series 100 & Series 200 CHEMTECH Pumps Feature:

- Designed to guard against unnecessary down time.
- Kop Kit contains recommended spare parts most likely to require normal maintenance.
- Contains valve cartridges with o-rings, head, diaphragm, secondary o-ring seal, head screen, & washers.
- Carded and shrink wrapped for display.

Stocked KOP Kits for Repairs: Keep-On-Pumping Kits

Part Number	Series	Fits Models	Tubing Size	List Price
KX030XAAAAAXXX	100&200	3-100 GPD	1/2" OD	\$ 473.92



C Plus Series



ISO 9002

Materials of Construction:	
Pump Head	PVC
Diaphragm	PTFE faced, Hypalon backed
Valve Seats/ O-rings	Hypalon
Tubing	Clear PVC
Ball Checks	Ceramic
Fittings	PVC

PULSATRON®

PULSATRON "C" Series Electronic Metering Pump

Features:

- Solenoid driven assembly - no motors.
- Reliable metering performance.
- Rated "hot" for continuous use.
- High viscosity capable up to 1000 cps.
- Leak free, seal-less liquid end.
- Diaphragms are PTFE-faced, bonded to a composite of Hypalon & fabric layers and reinforced with a metal insert.
- Manual control by on-line adjustable stroke length (fixed stroke length.)
- Agency approved for outdoor and indoor use.
- Water resistant for outdoor applications.
- Highly reliable timing circuit.
- Guided ball check valve system to reduce back flow and enhance outstanding running characteristics.
- Premium standard wetted component material.
- Few moving parts, wall mountable.
- Safe and easy priming with durable leak-free bleed valve assembly.
- Max pressure rating: 80 psi.
- Maximum 30 gallons per day.

PULSATRON "C PLUS" Series Electronic Metering Pump

Features:

- Same as above plus:
- Manual control by on-line **adjustable** stroke length **and** stroke rate.
- Manufactured for AGI in a ISO 9002 facility.

PULSATRON Stocked Electronic Models

Part Number	Series	Pressure PSI	Max GPD	Voltage	Suction & Discharge Tube OD	List Price
LC54SA-VHC1-XXX	C	80	30	115	3/8"	\$ 1353.58
LD54SA-VHC1-xxx	C Plus	80	30	115	3/8"	1621.20

* Additional Pulsatron models are available. Contact your sales representative.

C Plus Series
Stocked* Parts for PULSATRON C and C Plus Series Pumps

Part Number	Description	List Price
L3300H01-PVC	3/8" OD Bleed Valve Assembly	\$ 240.40
L3300H03-PVC	1/2" OD Bleed Valve Assembly	240.40
L3101HC1-PVC	3/8" OD C+ Suction valve	121.56
L3201HC1-PVC	3/8" OD C+ Discharge Valve	121.56
L3201HCA-PVC	1/2" OD C+ Discharge valve	130.37

* Other Series C and C Plus parts may be ordered. Contact your sales representative.

Kop Kit®
KOP Kit® for PULSATRON Series Pumps Feature:

- Designed to guard against unnecessary down time.
- Kop Kit contains recommended spare parts most likely to require normal maintenance.
- Contains valve cartridges with o-rings, head, diaphragm, secondary o-ring seal, head screen, & washers.
- Carded and shrink wrapped for display.

Stocked K.O.P. Kits for Repairs: Keep-On-Pumping Kits

NEW Part Number	Series	Fits Models	Suction Disch. Tubing Size	List Price
K4VHC1	C	30 GPD	3/8" OD	\$ 426.38
K3VHC1	C Plus	12 GPD	3/8" OD	364.90
K3VHCA	C Plus	12 GPD	1/2" OD	364.90
K4VHC1	C Plus	30 GPD	3/8" OD	426.38
K4VHCA	C Plus	30 GPD	1/2" OD	473.92

XP Series
CHEM-TECH XP Series Peristaltic Pump Features:

- Peristaltic technology delivers worry-free dosing, easy operations and minimal maintenance.
- Include adjustable, on/off with current interrupter timer.
- All metal drive gears and gear train. Metal gear housing.
- 3 piece roller design.
- Self priming.
- 115 V, 60 Hz

Part Number	Max PSI	GPD	RPM	Ctn Qty	List Price
XP015LAHX	110	15	50	1	\$ 1692.20
XP030LAHX	80	30	30	1	1700.49

Additional models are available with or without complete tank system.

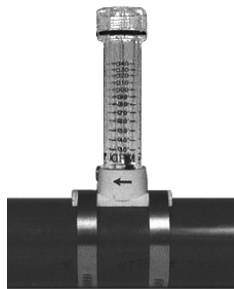

U88 Series

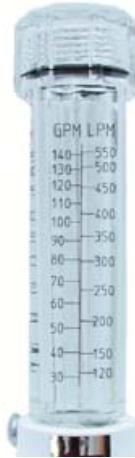

Flow Meter Features:

- Economical, easy to install, easy to maintain.
- Calibrated in GPM/LPM with easy-to-read numbering.
- Available 1" - 4" pipe size.
- Durable acrylic construction.
- Supplied with 2 clamps and rubber gasket seal.
- Maximum temperature limit = 120°F, Maximum pressure limit = 120 psi.

ISO 9002



Part Number	Nominal Pipe Size	Range GPM/LPM	List Price
U8800424	1"	5-35 / 20-130	\$ 308.67
U8800439	1 1/2"	20-80 / 80-300	308.67
U8800440	2"	30-140 / 120-550	308.67
U8800441	2 1/2"	40-200 / 160-750	308.67
U8800442	3"	80-350 / 300-1300	308.67
U8800443	4"	150-600 / 600-2200	308.67

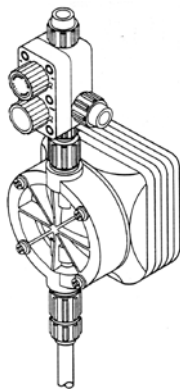

DG/5FV De-gas Five Function Valve Features:

- De-Gas - Bypass gasses and fluid during normal pump operation. Allows for the constant removal of gases that would otherwise "air bind" the pump.
- Back Pressure - Maintains output reproducibility and allows metering into atmospheric discharge.
- Anti-siphon - Prevents siphoning through the pump when point of injection is lower than the pump or into the suction line of another pump. Rated at total vacuum.
- Air Bleed - Used during priming to manually remove air from the pump head.
- Discharge Drain - Depressurize pump discharge line without loosening tubing or fittings. Protects the operator from chemical exposure.

Operation:

- The functions are selected by setting two, independent dual position selector knobs.
- The DG/5FV's compatible with most **PULSATRON** and **CHEMTECH** series pumps. Connected to the existing discharge valve the DG/5FV is capable of handling a large output flow as well as viscous liquids. A return port located on the side body provides flow of chemical back to the solution tank when in the degas, air bleed or drain discharge mode.
- Degas/bypass volume is adjustable, typically 1-10% of pump output.

Specifications:

Maximum Flow	240 gpd
Minimum Flow	3 gpd
Max Viscosity	1000 cps
Max Pressure	Up to 250 psi

Materials of Construction:

Valve Body	PVD
Diaphragm	PTFE faced Hypalon
O-rings	Viton or Hypalon
Hardware	188 Stainless steel (recessed)

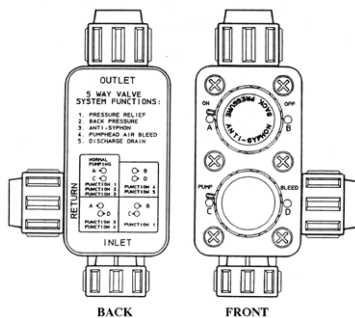

L385 Series

Part Number	Description	O-rings	Valve Body	Connection	List Price
L385KH03-PVD	DG/5FV De-Gas Valve	Hypalon	PVD	1/2" OD tubing	\$ 907.44

ISO 9002

Solution Tanks
Solution Tank Features:

- High density polyethylene
- 5 gallon marked increments.
- Add "AT" to fitting part number for factory installed bulkhead fittings.

Part Number	Description	List Price
40375	15 Gallon liner with cover 25" x 14 1/2"	\$ 635.58
40360	30 Gallon liner with cover 32" x 18 1/2" Brine Tank	896.41
J40366	50 Gallon liner with rigid cover 42 1/2" x 18 1/2" (b) 23 (t)	1544.30
26860	3/8" Bulk Head Fitting (AT) installed at factory	119.73

40360

UD001-238NU

Uni-Dose® UD Series Chemical Metering Pump Features:

- Universal solution engineered to address common well water treatment requirements. Single model with simplified design eases installation, maintenance and operation.
- Single speed control knob with precise capacity control with output range of 1 to 24 gallons per day at 80 psi.
- Advanced noise reduction design for residential applications.
- Integrated FastPrime™ priming valve for fast and easy startup.
- Fully enclosed NEMA 4X/ IP65 housing for protection in either indoor or outdoor installations. Heat resistance to 122°F
- Universal 115-230V 50/60 Hz power supply with internal varistor and fuse protect from power surge damage.
- Includes pump, tubing connection hardware, injection check valve, foot valve with strainer, ceramic weight for suction tubing, UV resistant PE tubing, flexible vinyl tubing and USA 120V or 230V plug power cord.

Technical Data:	
Output Range	1-24 GPD (0.16-3.8LPH)
Pressure Range	80 PSI (5.5 Bar)
Flow Rate Control	Variable speed, fixed stroke
Min Stroke	1 SPM
Max Stroke	160 SPM
Electric Supply	115-230V, 50/60 Hz
Max Current @ 120 VAC	0.3 amps
Installation	Indoor/outdoor
NEMA/IP Rating	NEMA 4X/IP65
Certifications	NSF 61, UL
Suction/Discharge	Single cartridge check valve
Dimensions	4.69" w x 7.83" h x 8.5" d

Output Information: UD Model	
Gallons per Day	1.0 Min - 24.0 Max
Gallons per Hour	0.04 Min - 1.0 Max
Liters per Day	3.79 Min - 90.85 Max
Liters per Hour	0.16 Min - 3.80 Max
mL/cc per Min	2.7 Min - 63.0 Max

Part Number	Description	List Price
UD001-238NU	UD Series Pump 120V	\$1247.76
UD002-238NU	UD Series Pump 230V	1247.76

All LMI pumps are drop shipped direct from factory.

Comparison		NEW UD Series	PREVIOUS U Series
Performance	Output Range	1-24 GPD (0.16-3.8 LPH)	1.2-30 GPD (0.19-4.7 LPH)
	Pressure Range	80 PSI (5.5 Bar)	80 PSI (5.5 Bar)
	Max Stroking Frequency	160 SPM	60 SPM
	Flow Rate Control	Variable speed, Fixed length	Fixed or Variable speed, Variable length
	Electrical Input	115V or 230V (US 120 or 230 plug)	115V or 230V (US 120 or 230 Plug)
Liquid End	LE Materials	PVC head and fittings	PVC head and fittings
	LE diaphragm	Teflon faced	Sanoprene
Features	Model	1 model	14 models
	UV resistance	UV resistance plastic	Not UV resistant
	Weather and Heat	Outdoor rated to 122°F	Outdoor rated
	Surge Protection	Protective fuse	Integrated pulsar
	Priming	Integrated priming valve	3 Function valve
	Common Features	Mounting points, footprint, tubing connections, check valves, cartridges	
	Approvals	Electrical Approvals	UL
NEMA/IP Rating		NEMA 4X/IP65	X
NSF Rating		NSF 61	NSF 61
Sales	Warranty	1 year	1 year



UD001-238NU

Parts for Uni-Dose UD Series Pump

Part Number	Description	Ctn Qty	List Price
10123	Strainer, Foot Valve PP	10	\$ 61.25
10322	Ceramic Weight, Suction tubing	10	60.24
10469-06	Tubing Vinyl, 0.375 OD X 0.062, 6 Feet	1	72.06
27342-16	Tubing PE, 0.375 OD X 0.062, 16 Feet	1	160.45
36103	O-Ring, 0.549ID, Polyprel	10	48.31
48349	O-Ring, 0.424ID, Polyprel	10	52.16
48617	Injection Check Valve Body	10	120.55
48728	Injection Valve ASM	1	347.78
48795	Injection Cartridge Valve	10	131.90
70192	Ferrule, Male .375 OD	1	33.26
70193	Ferrule, Female .375 OD	1	30.02
77383	Tubing Connection Kit	1	80.25
SP-238	Rebuild Kit	1	521.47
U48851	Power Cord	1	326.10