

POOL & SPA



Ball Valves - Single Union, Molded in place, 3-way	15-20
Boss™ Adhesives, Lubricants & Sealants	43-44
Butterfly Valves, Accessories, Installation Kits	27-31
Check Valves	23-25
Clear Braided PVC Hose	33-34
Concrete Repair	49-50
Equipment Pads	51
Float Valves	26
Flowmeters	14
Installation & Repair Accessories and Fittings	45-48
Pipe & Hose Cutters, Saws	39-42
Pool Floats	1
Pressure Gauges	7-10
Pressure Gauges - Liquid Filled	11-12
Pumps, Utility, Cover	64
Rope	3
Rope & Float Kits	2
Rope Anchors, Hooks & Accessories	4
Service Accessories	52
Slice Gate Valves	21-22
Specialty Pool & Spa Fittings	6
Test Kits & Specialty Gauges	13-14
Tubing	35-36
Tubing Fittings	37-38
Unions	5
Wingmaster Pool Service Tools	53-60
Winterizing Plugs	61-62
Winterizing Products	63



IF Series



HF Series



RBF Series

HARVARD Handi-Lock® Float Features:

- Made of polyethylene and treated with chlorine inhibitors and ultraviolet stabilizers for durability and long life.
- Self locking feature fixes on line without additional expense of float keepers or wedges.
- Three sealed compartments for optimum buoyancy in case of puncture.
- Three inside diameters to accommodate 3/8", 1/2" or 3/4" rope (either hollow braid or twisted).
- Patented. Made in the USA



HARVARD High Impact Styrene Float Features:

- Blue and white high impact styrene.
- Fits 3/8" hollow braid rope.



HARVARD Rainbow Style Float Features:

- Polyethylene
- Unsinkable
- Durable
- Chlorine inhibitors and ultraviolet stabilizers added.
- 3" x 5" for 1/2" pool rope and 5" x 9" for 3/4" pool rope available.



Part Number	Float Size	Rope Size	Color	Ctn Qty	List Price
IF3538	3" x 5"	3/8"	Blue/White/Blue	50	\$ 9.31
IF3538R	3" x 5"	3/8"	Red/White/Red	50	9.31
IF3538O	3" x 5"	3/8"	Orange/White/Orange	50	9.31
IF3550	3" x 5"	1/2"	Blue/White/Blue	50	9.31
IF3550R	3" x 5"	1/2"	Red/White/Red	50	9.31
IF3550O	3" x 5"	1/2"	Orange/White/ Orange	50	9.31
IF3550RWB	3" x 5"	1/2"	Red/White/Blue	50	9.31
IF3550 ALL BLUE	3" x 5"	1/2"	Blue/Blue/Blue	50	9.31
IF3550 ALL RED	3" x 5"	1/2"	Red/Red/Red	50	9.31
IF3550 ALL WHITE	3" x 5"	1/2"	White/White/White	50	9.31
IF5950	5" x 9"	1/2"	Blue/White/Blue	24	17.82
IF5950R	5" x 9"	1/2"	Red/White/Red	24	17.82
IF5950O	5" x 9"	1/2"	Orange/White/Orange	24	17.82
IF5950W	5" x 9"	1/2"	White/White/White	24	17.82
IF5975	5" x 9"	3/4"	Blue/White/Blue	24	17.82
IF5975R	5" x 9"	3/4"	Red/White/Red	24	17.82
IF5975O	5" x 9"	3/4"	Orange/ White/Orange	24	17.82
IF5975RWB	5" x 9"	3/4"	Red/White/Blue	24	17.82
HF35	3" x 5"	3/8"	Blue/White	10	4.94
RBF35BW	3" x 5"	1/2"	Blue/White	100	6.92
RBF35RW	3" x 5"	1/2"	Red/White	100	6.92
RBF35YW	3" x 5"	1/2"	Yellow/White	100	6.92
RBF35W	3" x 5"	1/2"	Solid White	100	6.92
RBF59BW	5" x 9"	3/4"	Blue/White	24	17.47
RBF59RW	5" x 9"	3/4"	Red/White	24	17.47
RBF59YW	5" x 9"	3/4"	Yellow/White	24	17.47
RBF59WHITE	5" x 9"	3/4"	Solid White	24	17.47
RBF59RED	5" x 9"	3/4"	Solid Red	24	17.47



IFK Series

IFK Series Float Kit Features:

- Blue and White Handi-Lock® Floats packaged for 16', 18', 20', 22' and 25' pools.
- Each partially assembled kit contains rope, Handi-Lock® Floats, 2 chrome plated brass rope hooks, splicing FID, and a full set of illustrated instructions.
- Individually packaged in shelf stackable boxes.
- 4 kits per master carton.



RFK Series

RFK Series Float Kit Features:

- Blue and White styrene float lane markers packaged for 12', 14', 16', 18', 20', 22' and 25' pools.
- Completely assembled and ready to install.
- Each individually bagged kit contains braided polypropylene rope with attractive blue/white floats, prefixed at regular intervals and two chrome plated brass hook eyes.

Part Number	Pool Size	Rope Length	Rope Size	Floats	Ctn Qty	List Price
IFK16	16'	18'	3/8"	5	4	\$ 98.55
IFK18	18'	20'	3/8"	6	4	110.86
IFK20	20'	22'	3/8"	7	4	123.31
IFK22	22'	24'	3/8"	7	4	123.85
IFK25	25'	27'	3/8"	8	4	136.59
RFK12	12'	14'	3/8"	5	6	56.38
RFK14	14'	16'	3/8"	5	6	56.39
RFK16	16'	18'	3/8"	5	6	69.91
RFK18	18'	20'	3/8"	7	6	82.08
RFK20	20'	22'	3/8"	9	4	97.48
RFK22	22'	24'	3/8"	9	4	103.37
RFK25	25'	27'	3/8"	10	4	109.29
RFK30	30'	28'	3/8"	14	1	105.43

Custom Float Kits also available on a special order basis.



PR Series



BPR Series

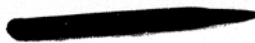

FID

Pool Rope Features:

- Polypropylene.
- Floatable.
- Waterproof.
- Rot Resistant.
- Easy to Handle.
- Resists Oil and Gasoline.
- Resists Most Chemicals.
- Resistant to Abrasion.
- Resistant to Color Fading.

Part Number	Color	Diameter	Length	List Price
Twisted Pool Rope				
YR25-500	Solid Yellow	1/4"	500'	\$ 64.07
PR25-6	Blue/White	1/4"	600'	76.58
YR25-1	Solid Yellow	1/4"	1000'	127.61
PR38-3R	Red/White	3/8"	300'	106.89
PR38-3W	Solid White	3/8"	300'	106.89
PR38-4	Blue/White	3/8"	400'	134.81
PR38-6	Blue/White	3/8"	600'	202.08
PR38-6R	Red/White	3/8"	600'	202.08
PR38-6O	Orange/White	3/8"	600'	202.08
PR38-6W	Solid White	3/8"	600'	202.08
PR38-6Y	Solid Yellow	3/8"	600'	202.08
PR50-3	Blue/White	1/2"	300'	149.80
PR50-3R	Red/White	1/2"	300'	149.80
PR50-3O	Orange/White	1/2"	300'	149.80
PR50-6	Blue/White	1/2"	600'	299.60
PR50-6R	Red/White	1/2"	600'	299.60
PR50-6O	Orange/White	1/2"	600'	299.60
PR50-6W	Solid White	1/2"	600'	299.60
PR50-6Y	Solid Yellow	1/2"	600'	299.60
PR58-6	Blue/White	5/8"	600'	459.56
PR75-3	Blue/White	3/4"	300'	396.53
PR75-3R	Red/White	3/4"	300'	396.53
PR75-3O	Orange/White	3/4"	300'	396.53
PR75-3W	Solid White	3/4"	300'	396.53
PR75-6	Blue/White	3/4"	600'	677.96
PR75-6R	Red/White	3/4"	600'	677.96
PR75-6O	Orange/White	3/4"	600'	677.96
PR75-6W	Solid White	3/4"	600'	677.96
PR75-6Y	Solid Yellow	3/4"	600'	677.96
PR75-1	Blue/White	3/4"	1000'	1232.15
Braided Pool Rope				
BPR38-5	Blue/White	3/8"	500'	145.38
Splicing Fid				
FID	Splicing Fid, For 3/8" braided rope			2.42

Chrome Plated Brass Rope Accessory Features:

- Bright chrome finished brass rope accessories.
- Precision cast from corrosion resistant brass.
- Stainless steel fasteners.
- Black or White EPDM gaskets.
- Fully assembled.



HOE2

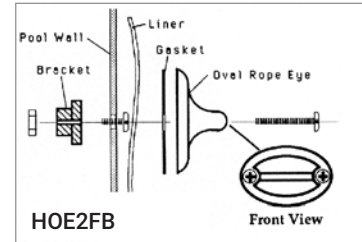
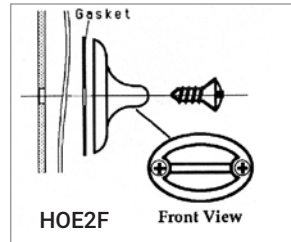
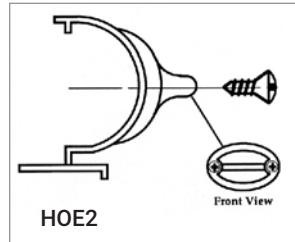

Part Number	Description	Ctn Qty	List Price
HOE2	Chrome Plated Brass CURVED COPING MOUNT Oval Rope Anchor (Set of 2 w/ ss self tap screws)	72	\$ 41.63
HOE2F	Chrome Plated Brass FLAT WALL MOUNT Oval Rope Anchor (Set of 2 w/ ss self tap screws, EPDM gasket)	6/72	35.65
HOE2FB	Chrome Plated Brass FLAT WALL MOUNT Oval Rope Anchor w/ brass mounting bracket and hardware (Set of 2 w/ ss screws, EPDM gasket, brass mounting brackets)	6/72	57.98
HCA	Chrome Plated Brass Cup Anchor for concrete pools.	12/120	21.96
HEBA	Chrome Plated Brass wall mount eye with washer gasket and nut for vinyl liners. 1-3/8" long bolt	20/200	13.55
HPRS	Chrome Plated Strap Type Rope Anchor used under coping for vinyl pools. 14" long	12/252	17.41
HRH	Chrome Plated Brass "S" Rope Hook for 1/4"-1/2" rope	500	13.32
AGHP52	CLEAT Style Chrome Plated Brass Hook for 3/8" & 1/2" rope w/ ss screws	125	32.10
AGHP53	CLEAT Style Chrome Plated Brass Hook for 3/4" rope w/ ss screws	125	45.60



HCA

HEBA



HPRS



HRH



AGHP



PVC Sch 80 Union Features:

- Ideal for swimming pool, spa and plumbing installations.
- EPDM O-Ring seal.
- Working pressure: 150 PSI at 72°F, 100 PSI at 120°F.
- Meets ASTM standards for Schedule 80 construction.
- Manufactured for AGI in an ISO 9002 facility.
- NSF listed.
- Available white or gray.
- **Third party certified NSF/ANSI 61&372.**

MATERIAL SPECIFICATIONS

Body	PVC
End Connector	PVC
Union Nut	PVC
O-Ring	EPDM

ISO 9002



DIMENSIONS (IN.)	SIZE	d3	D1	D2	L
	1/2"	.51	1.21	1.80	2.11
	3/4"	.71	1.45	2.15	2.42
	1"	.92	1.76	2.58	2.69
	1 1/4"	1.17	2.11	3.20	3.32
	1 1/2"	1.52	2.54	3.83	3.40
	2"	1.92	3.05	4.68	3.71
	3"	2.84	3.52	6.10	4.96
	4"	3.94	4.52	8.86	6.30

Part Number	IPS Size	Ctn Qty	List Price		
SCHEDULE 80 - WHITE			PV797	PV798	PV799
SLIP X SLIP	FIPT X FIPT	SLIP X FIPT	SXS	TXT	SXT
PV797-1/2	PV798-1/2	1/2"	36	\$ 5.17	\$ 5.42
PV797-3/4	PV798-3/4	3/4"	24/144	6.81	7.07
PV797-1	PV798-1	1"	12/96	8.76	9.36
PV797-1 1/4	PV798-1 1/4	1 1/4"	12/96	15.58	16.42
PV797-1 1/2	PV798-1 1/2	PV799-1 1/2	8/64	19.69	20.48
PV797-2	PV798-2	2"	4/48	27.40	28.81
SCHEDULE 80 - GRAY			PV697	PV698	
slip x slip	FIPT x FIPT		SxS	TXT	
PV697-1/2	PV698-1/2	1/2"	36/288	\$ 5.17	\$ 5.45
PV697-3/4	PV698-3/4	3/4"	24/144	6.83	7.21
PV697-1	PV698-1	1"	12/96	8.76	9.55
PV697-1 1/4	PV698-1 1/4	1 1/4"	12/96	15.58	16.20
PV697-1 1/2	PV698-1 1/2	1 1/2"	8/64	19.69	20.88
PV697-2	PV698-2	2"	4/48	27.92	29.35
PV697-3	PV698-3	3"	2/12	48.77	50.44
PV697-4		4"	1/4	108.26	

Replacement O-Ring for PV797, PV798, PV799, PV697, PV698

PV796-1/2	1/2"	1	\$ 0.43
PV796-3/4	3/4"	1	0.43
PV796-1	1"	1	0.52
PV796-1 1/4	1 1/4"	1	0.52
PV796-1 1/2	1 1/2"	1	0.86
PV796-2	2"	1	0.86

Union Repair Split Nut

SNR150	1 1/2" FBT Repair Split Nut w/ Screw	125	7.60
SNR200	2" FBT REpair Split Nut w/ Screw	100	8.37





SPA1512

Pool/Spa Hose Adapter Features:

- Larger hex nut than most other styles
- Ribbed insert end to promote a tight seal and tapered thread to prevent "bottoming out" during installation
- White ABS plastic

Part Number	Description	Ctn Qty	List Price
SPA1512	1 1/2" mip x 1 1/2", 1 1/4" combo hose adapter	100	\$ 2.38

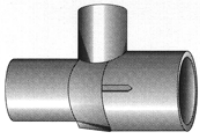

473-210



B1241

Part Number	Description	Ctn Qty	List Price
Venturi Tee			
473-825	3/4" x 1" x 3/4" Venturi Tee	50	\$ 22.93
473-210	1 1/2" x 1 1/2" x 3/4" Venturi Tee	25	27.92

Fittings

B1241-00	1 1/2" 90 elbow, spigot x spigot	25	20.39
----------	----------------------------------	----	-------



SW406 Series



SW409 Series

PVC Sweep Elbow Features:

- Exceeds requirements of CA Title 24, Pool Systems & Equipment Installs.
- Sweep Elbows reduce head loss.
- Socket dimensions to Sch 40 ASTM D 2464.
- Listed to NSF/ANSI Standard 50 Swimming Pools, Spas and Hot Tubs - Circulation System Component.

Part Number	Description	Ctn Qty	List Price
SW406-015	1 1/2" PVC Sweep Elbow SL x SL	25	\$ 7.16
SW406-020	2" PVC Sweep Elbow SL x SL	25	8.54
SW406-025	2 1/2" PVC Sweep Elbow SL x SL	25	13.72
SW409-015	1 1/2" PVC Sweep Elbow SL x SPG	25	6.84
SW409-020	2" PVC Sweep Elbow SL x SPG	25	8.12



Schedule 80 CPVC Nipple Features:

- Sturdy.
- Lightweight.
- Chemical Resistant.
- Gray.
- Threaded on both ends.



SCHEDULE 80 CPVC PIPE NIPPLES

PART NO.	SIZE	CTN QTY	LIST PRICE
CPVC1XCLOSE	1 X CLOSE	25	\$ 4.57
CPVC11/2xCLOSE	1 1/2 x CLOSE	25	6.64
CPVC11/2X6	1 1/2 X 6	25	18.13
CPVC11/2x8	1 1/2 x 8	25	24.41
CPVC11/2X12	1 1/2 X 12	25	36.23
CPVC2XCLOSE	2 X CLOSE	25	11.09
CPVC2X6	2 X 6	25	27.28
CPVC2x8	2 x 8	25	33.89
CPVC2X12	2 X 12	BULK	49.78
CPVC2x24	2 x 24	BULK	100.73



Pressure Gauge

ISO 9001

Pressure Gauge Features:

- Rugged precision made phosphor-bronze Bourdon tube movements assuring maximum accuracy (+/- 3-2-3%) under adverse field conditions.
- **TO BE USED WITH AIR OR WATER ONLY.**
- Manufactured for AGI in an ISO 9001 facility.

POLYPROPYLENE CASE:

- Bourdon tube movement is totally enclosed in corrosion resistant polypropylene housing, acrylic lens.
- Resists rust, electrolytic action and chemical solvents.
- Brass sockets standard.

STEEL CASE:

- Deep drawn one piece steel housing encases a quality movement.
- Genuine mar-resistant glass lens and brass socket connections are standard.



CAUTION

Part Number	Case	Range	Type	Dial Size	MIP Conn.	Ctn Qty	List Price
2" DIAL SIZE, PLASTIC CASE, DRY							
IPPG302-4L	Plastic	0-30#	Pressure	2"	1/4 Lower	100	\$ 9.47
IPPG302-4B	Plastic	0-30#	Pressure	2"	1/4 Back	100	9.47
IPPG602-4L	Plastic	0-60#	Pressure	2"	1/4 Lower	100	9.47
IPPG602-4B	Plastic	0-60#	Pressure	2"	1/4 Back	100	9.47
IPPG1002-4L	Plastic	0-100#	Pressure	2"	1/4 Lower	100	9.47
IPVG302-4L	Plastic	0-30 Hg"	Vacuum	2"	1/4 Lower	100	10.54
2" DIAL SIZE, STEEL CASE, DRY							
IPG302-4L	Steel	0-30#	Pressure	2"	1/4 Lower	100	9.76
IPG302-4B	Steel	0-30#	Pressure	2"	1/4 Back	100	9.76
IPG302-8L	Steel	0-30#	Pressure	2"	1/8 Lower	100	9.76
IPG302-8B	Steel	0-30#	Pressure	2"	1/8 Back	100	9.76
IPG602-4L	Steel	0-60#	Pressure	2"	1/4 Lower	100	9.76
IPG602-4B	Steel	0-60#	Pressure	2"	1/4 Back	100	9.76
IPG602-8L	Steel	0-60#	Pressure	2"	1/8 Lower	100	9.76
IPG1002-4L	Steel	0-100#	Pressure	2"	1/4 Lower	100	9.76
IPG1002-8B	Steel	0-100#	Pressure	2"	1/8 Back	100	9.76

Pressure Gauges - Dry



CAUTION



Part Number	Case	Range	Type	Dial Size	MIP Conn.	Ctn Qty	List Price
2" DIAL SIZE, STEEL CASE, DRY							
IPVG302-4B	Steel	0-30 Hg"	Vacuum	2"	1/4 Back	100	10.54
IPVG302-8L	Steel	0-30 Hg"	Vacuum	2"	1/8 Lower	100	10.54
IPCG3602-4L	Steel	30Hg"/60#	Vacuum/PResure	2"	1/4 Lower	200	10.54
2 1/2" DIAL SIZE, DRY							
IPG3025-4L	Steel	0-30#	Pressure	2 1/2"	1/4 Lower	100	12.43
IPG6025-4L	Steel	0-60#	Pressure	2 1/2"	1/4 Lower	100	12.43
IPG10025-4L	Steel	0-100#	Pressure	2 1/2"	1/4 Lower	50	12.43
IPG16025-4L	Steel	0-160#	Pressure	2 1/2"	1/4 Lower	100	12.43
IPVG3025-4L	Plastic	0-30 Hg"	Vacuum	2 1/2"	1/4 Lower	50	12.43
4 1/2" DIAL SIZE, STEEL CASE, DRY							
IPG3045-4L	Steel	0-30#	Pressure	4 1/2"	1/4 Lower	50	26.28
IPG6045-4L	Steel	0-60#	Pressure	4 1/2"	1/4 Lower	50	26.28
IPG10045-4L	Steel	0-100#	Pressure	4 1/2"	1/4 Lower	50	26.28
IPVG3045-4L	Steel	30 Hg"	Vacuum	4 1/2"	1/4 Lower	50	26.28
IPCG36045-4L	Steel	30 Hg"/60#	Vacuum/Pressure	4 1/2"	1/4 Lower	50	26.28
IPCG31045-4L	Steel	30 Hg"/160#	Vacuum/Pressure	4 1/2"	1/4 Lower	50	26.28



IPPG or IPG Series

ISO 9001

Pressure Gauge Features:

- Rugged precision made phosphor-bronze Bourdon tube movements assuring maximum accuracy (+/- 3-2-3%) under adverse field conditions.
- **TO BE USED WITH AIR OR WATER ONLY.**
- Manufactured for AGI in an ISO 9001 facility.
- Bourdon tube movement is totally enclosed in corrosion resistant housing.
- Resists rust, electrolytic action and chemical solvents.
- **Third party certified to NSF/ANSI 61&372.** No Lead brass sockets.
- Deep drawn one piece steel or molded plastic housings encase a quality movement.
- Genuine mar-resistant glass or acrylic lens.



CAUTION

Part Number	Case	Range	Type	Dial Size	MIP Conn.	Ctn Qty	List Price
2" DIAL SIZE, PLASTIC CASE, DRY							
IPPG302-4LNL	Plastic	0-30#	Pressure	2"	1/4 Lower	100	\$ 11.49
IPPG302-4BNL	Plastic	0-30#	Pressure	2"	1/4 Back	100	11.49
IPPG602-4LNL	Plastic	0-60#	Pressure	2"	1/4 Lower	100	11.49
IPPG602-4BNL	Plastic	0-60#	Pressure	2"	1/4 Back	100	11.49
IPPG1002-4LNL	Plastic	0-100#	Pressure	2"	1/4 Lower	100	11.49
EIPPG1002-4LPNL	Plastic	0-100#	Pressure	2" No dial logo	1/4 Lower	100	10.86
IPPG1002-4BNL	Plastic	0-100#	Pressure	2"	1/4 Back	100	11.49
IPVG302-4LNL	Plastic	0-30 Hg"	Vacuum	2"	1/4 Lower	100	12.31
2" DIAL SIZE, STEEL CASE, DRY							
IPG152-4LNL	Steel	0-15#	Pressure	2"	1/4 Lower	100	10.78
IPG302-4LNL	Steel	0-30#	Pressure	2"	1/4 Lower	100	11.73
IPG302-4BNL	Steel	0-30#	Pressure	2"	1/4 Back	100	11.73
IPG302-8LNL	Steel	0-30#	Pressure	2"	1/8 Lower	100	11.73
IPG302-8BNL	Steel	0-30#	Pressure	2"	1/8 Back	100	11.73
IPG602-4LNL	Steel	0-60#	Pressure	2"	1/4 Lower	100	11.73
IPG602-4BNL	Steel	0-60#	Pressure	2"	1/4 Back	100	11.73
IPG602-8LNL	Steel	0-60#	Pressure	2"	1/8 Lower	100	11.73
IPG1002-4LNL	Steel	0-100#	Pressure	2"	1/4 Lower	100	10.70
EIPG1002-4LPNL	Steel	0-100#	Pressure	2" No dial logo	1/4 Lower	100	10.74
IPG1002-4BNL	Steel	0-100#	Pressure	2"	1/4 Back	100	11.73
IPG1002-8LNL	Steel	0-100#	Pressure	2"	1/8 Lower	100	11.73
IPG1002-8BNL	Steel	0-100#	Pressure	2"	1/8 Back	100	11.73
IPG1602-4LNL	Steel	0-160#	Pressure	2"	1/4 Lower	100	11.73

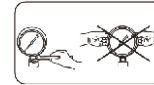
CAUTION

Part Number	Case	Range	Type	Dial Size	MIP Conn.	Ctn Qty	List Price
2" DIAL SIZE, STEEL CASE, DRY							
IPG2002-4LNL	Steel	0-200#	Pressure	2"	1/4 Lower	100	\$ 10.70
IPG2002-4BNL	Steel	0-200#	Pressure	2"	1/4 Back	100	11.73
IPG2002-8LNL	Steel	0-200#	Pressure	2"	1/8 Lower	100	11.73
IPG3002-4LNL	Steel	0-300#	Pressure	2"	1/4 Lower	100	11.73
IPVG302-4BNL	Steel	0-30 Hg"	Vacuum	2"	1/4 Back	100	12.31
IPVG302-8LNL	Steel	0-30 Hg"	Vacuum	2"	1/8 Lower	100	12.31
IPCG3102-4LNL	Steel	30 Hg"/160#	Vacuum/Pressure	2"	1/4 Lower	100	12.31
IPCG3602-4LNL	Steel	30Hg"/60#	Vacuum/PPressure	2"	1/4 Lower	200	12.31
2" DIAL SIZE, STAINLESS STEEL CASE, 316SS INTERNALS and MOUNT, DRY							
EIPG1002-4LSS316	Stainless Steel	0-100#	Pressure	2"	1/4 Lower	100	26.68
EIPG1002-4BSS316	Stainless Steel	0-100#	Pressure	2"	1/4 Back	100	31.89
EIPG2002-4LSS316	Stainless Steel	0-200#	Pressure	2"	1/4 Lower	100	26.68
EIPG2002-4BSS316	Stainless Steel	0-200#	Pressure	2"	1/4 Back	100	31.89
2 1/2" DIAL SIZE, DRY							
IPG1525-4LNL	Plastic	0-15#	Pressure	2 1/2"	1/4 Lower	100	15.03
IPG3025-4LNL	Steel	0-30#	Pressure	2 1/2"	1/4 Lower	100	15.03
IPG6025-4LNL	Steel	0-60#	Pressure	2 1/2"	1/4 Lower	100	15.03
IPG10025-4LNL	Steel	0-100#	Pressure	2 1/2"	1/4 Lower	50	15.03
IPG16025-4LNL	Steel	0-160#	Pressure	2 1/2"	1/4 Lower	100	15.03
IPG20025-4LNL	Steel	0-200#	Pressure	2 1/2"	1/4 Lower	100	15.03
IPG30025-4LNL	Steel	0-300#	Pressure	2 1/2"	1/4 Lower	50	15.03
IPG40025-4LNL	Steel	0-400#	Pressure	2 1/2"	1/4 Lower	50	15.03
IPVG3025-4LNL	Plastic	0-30 Hg"	Vacuum	2 1/2"	1/4 Lower	50	15.03
IPCG31025-4LNL	Steel	30 Hg"/160#	Vacuum/Pressure	2 1/2"	1/4 Lower	50	15.03
3 1/2" DIAL SIZE, STEEL CASE, DRY							
IPG3035-4LNL	Steel	0-30#	Pressure	3 1/2"	1/4 Lower	50	21.94
IPG10035-4LNL	Steel	0-100#	Pressure	3 1/2"	1/4 Lower	50	21.94
IPG20035-4LNL	Steel	0-200#	Pressure	3 1/2"	1/4 Lower	50	21.94
IPG30035-4LNL	Steel	0-300#	Pressure	3 1/2"	1/4 Lower	50	21.94
4 1/2" DIAL SIZE, STEEL CASE, DRY							
IPG3045-4LNL	Steel	0-30#	Pressure	4 1/2"	1/4 Lower	50	28.51
IPG6045-4LNL	Steel	0-60#	Pressure	4 1/2"	1/4 Lower	50	28.51
IPG10045-4LNL	Steel	0-100#	Pressure	4 1/2"	1/4 Lower	50	28.51
IPG20045-4LNL	Steel	0-200#	Pressure	4 1/2"	1/4 Lower	50	28.51
IPG30045-4LNL	Steel	0-300#	Pressure	4 1/2"	1/4 Lower	50	28.51
IPVG3045-4LNL	Steel	30 Hg"	Vacuum	4 1/2"	1/4 Lower	50	28.51
IPCG36045-4LNL	Steel	30 Hg"/60#	Vacuum/Pressure	4 1/2"	1/4 Lower	50	28.51
IPCG31045-4LNL	Steel	30 Hg"/160#	Vacuum/Pressure	4 1/2"	1/4 Lower	50	28.51



EILPG Series



ILPG Series

Liquid Filled Pressure Gauge Features:

- Stainless steel or black steel case
- Glycerine Filled, Phosphor bronze bourdon tube
- Accuracy +/- 3-2-3%
- 2" or 2 1/2" Dial face with clear acrylic lens
- Crimped stainless steel ring
- For use in high vibration, corrosion situations
- **TO BE USED WITH AIR OR WATER ONLY.**



CAUTION

Part Number	Case	Range	Type	Dial Size	MIP Conn.	Ctn Qty	List Price
2" DIAL SIZE, LIQUID FILLED							
EILPG302-4L	Steel	0-30#	Pressure	2"	1/4" Lower	100	\$ 12.30
EILPG602-4L	Steel	0-60#	Pressure	2"	1/4" Lower	100	12.30
EILPG602-4B	Steel	0-60#	Pressure	2"	1/4" Back	100	13.49
EILPG1002-4L	Steel	0-100#	Pressure	2"	1/4" Lower	100	12.30
EILPG1002-4B	Steel	0-100#	Pressure	2"	1/4" Back	100	13.49
EILPG1602-4L	Steel	0-160#	Pressure	2"	1/4" Lower	100	12.30
EILVG302-4L	Steel	0-30 Hg"	Vacuum	2"	1/4" Lower	100	14.79
EILPG302-4LSS	Stainless Steel	0-30#	Pressure	2"	1/4" Lower	100	19.53
EILPG602-4LSS	Stainless Steel	0-60#	Pressure	2"	1/4" Lower	100	19.53
EILPG602-4BSS	Stainless Steel	0-60#	Pressure	2"	1/4" Back	100	20.34
EILPG1002-4LSS	Stainless Steel	0-100#	Pressure	2"	1/4" Lower	100	19.53
EILVG302-4LSS	Stainless Steel	0-30 Hg"	Vacuum	2"	1/4" Lower	100	21.15
2 1/2" DIAL SIZE, LIQUID FILLED							
ILPG3025-4L	Stainless Steel	0-30#	Pressure	2 1/2"	1/4 Lower	50	20.87
ILPG6025-4L	Stainless Steel	0-60#	Pressure	2 1/2"	1/4 Lower	50	20.87
ILPG10025-4L	Stainless Steel	0-100#	Pressure	2 1/2"	1/4 Lower	50	20.87
ILPG16025-4L	Stainless Steel	0-160#	Pressure	2 1/2"	1/4 Lower	50	20.87
ILPG20025-4L	Stainless Steel	0-200#	Pressure	2 1/2"	1/4 Lower	50	20.87
ILVG3025-4L	Stainless Steel	0-30 Hg"	Vacuum	2 1/2"	1/4 Lower	50	23.81
ILCG36025-4L	Stainless Steel	30 Hg"/60#	Vacuum/Press	2 1/2"	1/4 Lower	50	24.67

Pressure Gauges - NO LEAD Liquid Filled



EILPG Series



ILPG Series

Liquid Filled Pressure Gauge Features:

- Stainless steel or black steel case.
- Glycerine filled, phosphor bronze bourdon tube.
- Accuracy +/- 3-2-3%.
- 2" or 2 1/2" Dial face with clear acrylic lens.
- Crimped stainless steel ring.
- For use in high vibration, corrosion situations.
- **Third party certified to NSF/ANSI 61&372.**
- No lead brass or stainless steel sockets.
- **TO BE USED WITH AIR OR WATER ONLY.**

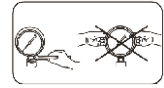

CAUTION

Part Number	Case	Range	Type	Dial Size	MIP Conn.	Ctn Qty	List Price
2" DIAL SIZE, LIQUID FILLED							
EILPG302-4LNL	Steel	0-30#	Pressure	2"	1/4" Lower	100	\$ 14.73
EILPG602-4LNL	Steel	0-60#	Pressure	2"	1/4" Lower	100	14.73
EILPG602-4BNL	Steel	0-60#	Pressure	2"	1/4" Back	100	16.38
EILPG1002-4LNL	Steel	0-100#	Pressure	2"	1/4" Lower	100	15.03
EILPG1002-4BNL	Steel	0-100#	Pressure	2"	1/4" Back	100	15.54
EILPG1002-8BNL	Steel	0-100#	Pressure	2"	1/8" Back	100	15.92
EILPG1602-4LNL	Steel	0-160#	Pressure	2"	1/4" Lower	100	14.73
EILPG2002-4LNL	Steel	0-200#	Pressure	2"	1/4" Lower	100	15.46
EILVG302-4LNL	Steel	0-30 Hg"	Vacuum	2"	1/4" Lower	100	17.48
EILVG302-4BNL	Steel	0-30 Hg"	Vacuum	2"	1/4" Back	100	18.81

EILPG302-4LSSNL	Stainless Steel	0-30#	Pressure	2"	1/4" Lower	100	22.20
EILPG602-4LSSNL	Stainless Steel	0-60#	Pressure	2"	1/4" Lower	100	22.20
EILPG602-4BSSNL	Stainless Steel	0-60#	Pressure	2"	1/4" Back	100	23.53
EILPG1002-4LSSNL	Stainless Steel	0-100#	Pressure	2"	1/4" Lower	100	22.20
EILPG1002-4LSS316*	Stainless Steel 316	0-100#	Pressure	2"	1/4" Lower	100	44.70
EILPG1002-4BSSNL	Stainless Steel	0-100#	Pressure	2"	1/4" Back	100	23.53
EILPG1002-4BSS316*	Stainless Steel 316	0-100#	Pressure	2"	1/4" Back	100	50.19
EILPG1602-4LSSNL	Stainless Steel	0-160#	Pressure	2"	1/4" Lower	100	22.20
EILPG2002-4LSSNL	Stainless Steel	0-200#	Pressure	2"	1/4" Lower	100	22.20
EILVG302-4LSSNL	Stainless Steel	0-30 Hg"	Vacuum	2"	1/4" Lower	100	24.45
EILVG302-4BSSNL	Stainless Steel	0-30 Hg"	Vacuum	2"	1/4" Back	100	25.79

* 316 Stainless steel internals and mount.

2 1/2" DIAL SIZE, LIQUID FILLED

ILPG3025-4LNL	Stainless Steel	0-30#	Pressure	2 1/2"	1/4 Lower	50	18.36
ILPG6025-4LNL	Stainless Steel	0-60#	Pressure	2 1/2"	1/4 Lower	50	18.36
ILPG10025-4LNL	Stainless Steel	0-100#	Pressure	2 1/2"	1/4 Lower	50	18.36
ILPG16025-4LNL	Stainless Steel	0-160#	Pressure	2 1/2"	1/4 Lower	50	18.36
ILPG20025-4LNL	Stainless Steel	0-200#	Pressure	2 1/2"	1/4 Lower	50	18.36
ILPG30025-4LNL	Stainless Steel	0-300#	Pressure	2 1/2"	1/4 Lower	50	18.36
ILPG40025-4LNL	Stainless Steel	0-400#	Pressure	2 1/2"	1/4 Lower	50	17.94
ILVG3025-4LNL	Stainless Steel	0-30 Hg"	Vacuum	2 1/2"	1/4 Lower	50	26.54
ILVG3025-4BNL	Stainless Steel	0-30 Hg"	Vacuum	2 1/2"	1/4 Back	50	27.86
ILCG36025-4LNL	Stainless Steel	30 Hg"/60#	Vacuum/Press	2 1/2"	1/4 Lower	50	27.51



Pool Test Kit Features:

- For pressure testing pool systems
- Unassembled kits individually boxed
- Includes PVC Sch 40 Reducing Tee, PVC Sch 40 Reducing Bushing, Brass Boiler Drain, 3/4", 60# 2" plastic case pressure gauge, 1/4" lower brass mount.

Part Number	Description	Ctn Qty	List Price
TK150	1 1/2" Pool Test Kit	8	\$ 59.01
TK200	2" Pool Test Kit	8	62.37



Pressure Air Test Gauge Features:

- Quick, easy means of pressurizing and monitoring plumbing systems for leakage.
- Attach to hose bibb.
- Includes brass hex manifold, air valve, 2" 200# gauge, garden hose thread fitting.

Part Number	Description	Ctn Qty	List Price
PATG200	Pressure Air Test Gauge	30	\$ 34.26



PGBS



Pressure Gauge Brass Snubber Features:

- Use with any pressure gauge subjected to rapidly fluctuating pressures or sudden shock pressure.
- Brass housing with high strength sintered, porous type snubbing element.

Part Number	Size/Description	Ctn Qty	List Price
PGBS1/4	1/4" mpt x 1/4" fpt Brass Snubber	50/500	\$ 10.21



PTG1002

Pressure Test Gauge Features:

- 0-100 psi, 2" plastic lens.
- Brass test fitting with pressure release button.
- Heavy rubber boot to protect gauge from damage.

Part Number	Size	Pressure Setting/Description	Ctn Qty	List Price
PTG1002	2" case	0-100# Pressure test gauge	50	\$ 21.26



WTG

Water Test Gauge Features:

- Quick, easy method to test a wide range of pressure systems for leakage.
- 2 1/2" dial face, steel case pressure gauge w/ plastic lens.
- With standard 3/4" FGHT swivel garden hose connection with rubber washer.
- Attach to hose bibbs, boiler drains and lawn faucets for pressure testing.
- "MP" series MAX pointer arm measures maximum water surge or pressure drop.
- Individually cartoned.



WTG MP



Part Number	Size	Pressure Setting/Description	PSI dial increments	Ctn Qty	List Price
WTG100	2 1/2"	0-100# water test gauge, fght	1	50	\$ 14.87
WTG200	2 1/2"	0-200# water test gauge, fght	2	50	14.87
WTG300	2 1/2"	0-300# water test gauge, fght	3	100	14.87
WTG100MP	2 1/2"	0-100# gauge with MAX pointer	1	50	15.89
WTG200MP	2 1/2"	0-200# gauge with MAX pointer	2	50	15.89
WTG300MP	2 1/2"	0-300# gauge with MAX pointer	3	50	15.89

GTG

GTMAV

GTM3/4

Gas Test Gauge Features:

- Quick, easy means of pressurizing & monitoring gas systems for leakage.
- Completely assembled - brass hex manifold, air valve with plastic cap and 2" dial face, steel case pressure gauge with plastic lens.
- Manifold also available separately: 3/4" fpt connection with 1/4" fpt gauge tap and 1/8" fpt air valve tap.
- Individually cartoned and available in 15, 30, 60 and 100 psi.

Part Number	Description	Gauge Increments	Ctn Qty	List Price
GTG15	Gas test gauge, 3/4" fpt, 0-15#	1/10 lb.	50	\$ 26.28
GTG30	Gas test gauge, 3/4" fpt, 0-30#	1/2 lb.	50	26.28
GTG60	Gas test gauge, 3/4" fpt, 0-60#	1/10 lb.	50	26.28
GTG100	Gas test gauge, 3/4" fpt, 0-100#	1 lb.	50	26.28
GTM3/4	Brass Gas test manifold only		100	13.70

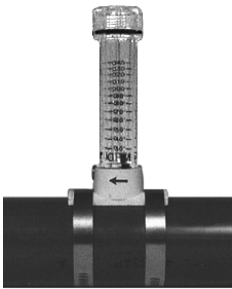
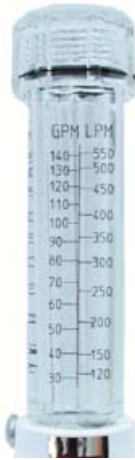
U88 Series

Flow Meter Features:



- Economical, easy to install, easy to maintain.
- Calibrated in GPM/LPM with easy-to-read numbering.
- Available 1" - 4" pipe size.
- Durable acrylic construction.
- Supplied with 2 clamps and rubber gasket seal.
- Maximum temperature limit = 120°F, Maximum pressure limit = 120 psi.

ISO 9002

Part Number	Nominal Pipe Size	Range GPM/LPM	List Price
U8800424	1"	5-35 / 20-130	\$ 308.67
U8800439	1 1/2"	20-80 / 80-300	308.67
U8800440	2"	30-140 / 120-550	308.67
U8800441	2 1/2"	40-200 / 160-750	308.67
U8800442	3"	80-350 / 300-1300	308.67
U8800443	4"	150-600 / 600-2200	308.67

PVC Single Union Ball Valve Features:



PV1450 Series



PV1452, PV1453 Series

ISO 9002



- PVC Type 1 construction for compatibility in joining rigid PVC and flex vinyl pipes.
- **PTFE seats.**
- **Double EPDM o-ring seal on stem: single EPDM o-ring seal on union end.**
- Fully round ball prevents foreign matter from scoring seats.
- Tee handle for quarter turn on/off with stops.
- Working pressure: 150 PSI at 72°F, 100 PSI at 120°F.
- Threaded or socket.
- Manufactured for AGI in an ISO 9002 facility.
- Imported

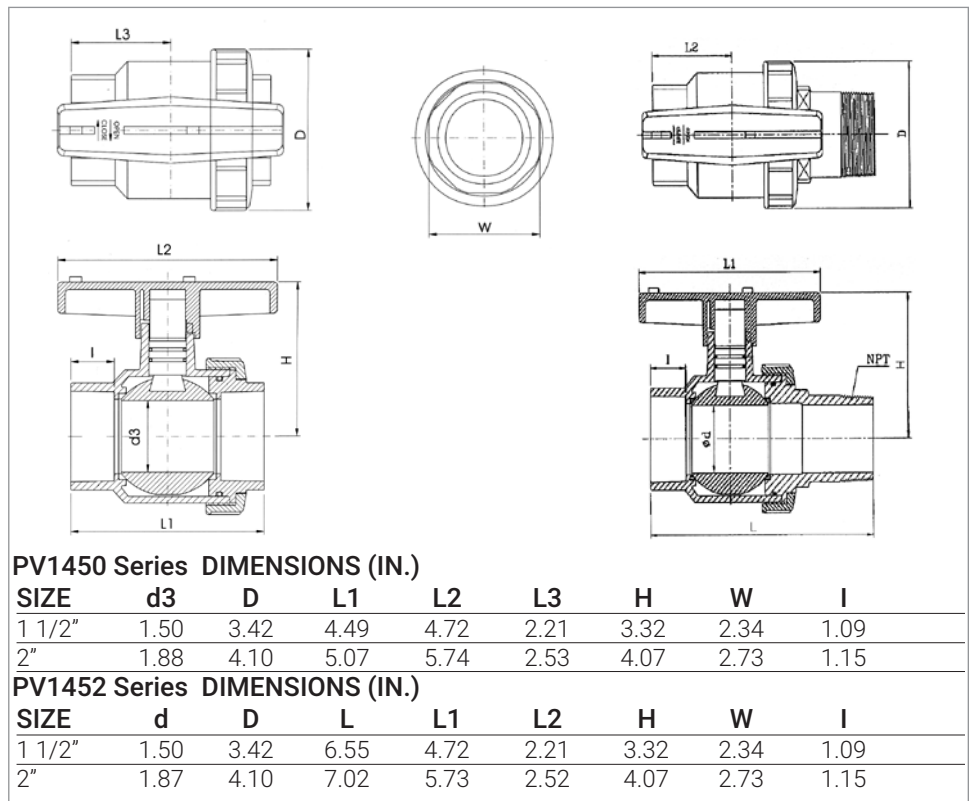

MATERIAL SPECIFICATIONS

Body	PVC
End Adapter	PVC
Union Nut	PVC
Ball	PVC
Stem	PVC
Handle	ABS
Union o-rings	EPDM
Seat Seals	PTFE
Stem o-rings	EPDM

Part Number	Threaded/Slip	Size	Ctn Qty	List Price
PV1450-11/2	Slip	1-1/2"	48	\$ 38.32
PV1450-2	Slip	2"	24	50.72
PV1451-11/2	Threaded	1-1/2"	48	38.32
PV1451-2	Threaded	2"	24	50.72
PV1452-11/2	Slip x Extended MIP	1 1/2"	24	37.96
PV1452-2	Slip x Extended MIP	2"	24	52.19
PV1453-11/2	FPT x Extended MIP	1 1/2"	24	37.96
PV1453-2	FPT x Extended MIP	2"	12	52.19

Valves - PVC Single Union, 3-way CPVC



PVC Single Union Ball Valve Features:



1350 Series



- PVC Type 1 construction for compatibility in joining rigid PVC and flex vinyl pipes.
- **Buna "N" O-Ring seal; HDPE seats.**
- 1-1/4 deep sockets on both ends for extra cementing surface area.
- Tee handle for quarter turn on/off with stops.
- Working pressure: 150 PSI at 72°F.
- Threaded or socket.

Part Number	Threaded/Socket	Size	Ctn Qty	List Price
1350-15	Socket	1-1/2"	12	\$ 65.51



Economy Series PVC Molded-In-Place Ball Valve Features:



- Heavy duty thermoplastic white PVC (Type 1, Grade 1) construction.
- White body, blue handle.
- **Straight lever** handle on 1/2" through 2". **Curved lever** handle on 2 1/2", 3" and 4".
- EPDM seats provide excellent chemical resistance.
- EPDM "o" ring stem seal.
- 150 PSI working pressure at 73°F water, non-shock.
- Maintenance free compact design.
- Severe shock loads and misalignment stress are absorbed by the valve body, not the ball & seat, minimizing the chance of uneven wear & leakage.
- Third party certified no lead to NSF/ANSI 61&372.
- Individually cartoned.
- Imported.

CV (GPM/(1 lbf/in ²) ^{1/2}) Opening Rate: 90°	
SIZE	CV
1/2"	14.5
3/4"	29.5
1"	48.0
1 1/4"	71.0
1 1/2"	135.0
2"	180.0
2 1/2"	225.0
3"	400.0
4"	865.9

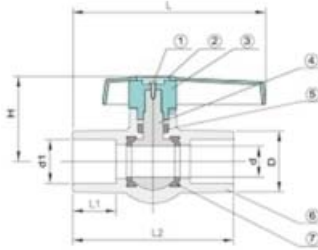

EMIP TE/SE Series IPS DIMENSIONS (mm)

SIZE	d	d1	D	L1	L	H
1/2"	15	21.54	31.4	19.6	91	34.5
3/4"	20	26.87	36.8	20.4	103	51.0
1"	25	33.65	43.0	26.4	119	58.5
1 1/4"	32	24.42	42.5	27.0	134	67.4
1 1/2"	36	48.56	63.2	30.9	154	73.2
2"	48	60.63	76.4	38.0	180	87.0
2 1/2"	63	73.38	90	45.0	182	103.5
3"	75	89.31	109	50.4	223	118.5
4"	97	114.76	132	62.6	252	130.3

MATERIAL SPECIFICATIONS

1	Screw	Zinc Plated Steel
2	Cap	ABS
3	Handle	ABS
4	Ball	PVC
5	Stem Seal o-ring	EPDM
6	Body	PVC
7	Seat Seal	EPDM

Threaded Part Number	Slip Part Number	Size	Master Case Qty	List Price
EMIP50TE	EMIP50SE	1/2"	210	\$ 3.22
EMIP75TE	EMIP75SE	3/4"	137	4.77
EMIP100TE	EMIP100SE	1"	95	6.86
EMIP125TE	EMIP125SE	1 1/4"	56	10.08
EMIP150TE	EMIP150SE	1 1/2"	36	13.29
EMIP200TE	EMIP200SE	2"	24	20.43
EMIP250TE	EMIP250SE	2 1/2"	9	52.61
EMIP300TE	EMIP300SE	3"	8	88.91
EMIP400TE	EMIP400SE	4"	6	149.29

Relations Between Temperature and Pressure

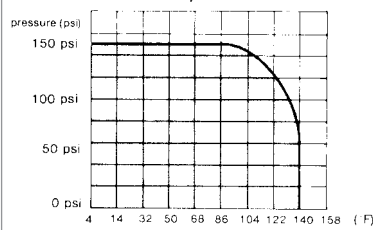





SCH 80 Series PVC Molded-In-Place Ball Valve Features:

- Heavy duty thermoplastic white PVC (Type 1, Grade 1) construction. Materials meet NSF standards.
- Meets ASTM 2467 Schedule 80.
- White body, red handle.
- Available with PTFE or EPDM seats providing excellent chemical resistance.
- EPDM "o" ring stem seal
- **150 PSI** working pressure at 73°F water, non-shock.
- Maintenance free compact design.
- Severe shock loads and misalignment stress are absorbed by the valve body, not the ball & seat, minimizing the chance of uneven wear & leakage.
- Individually cartoned.
- Manufactured for AGI in an ISO 9002 facility.
- **Third party certified to NSF/ANSI 61&372.**

MATERIAL SPECIFICATIONS	
Body	PVC
Seat Seal	EPDM, PTFE
Ball	PVC
Stem Seal o-ring	EPDM
Handle	ABS
Bolt	Zinc Plated Steel
Cap	ABS



Certified to
ANSI-NSF 61 &
ANSI-NSF 61 Annex G



ISO 9002

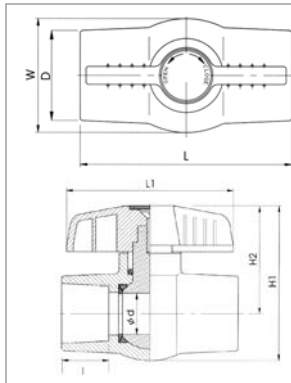

HMIP TE/SE and T/S Series IPS DIMENSIONS (IN.)

SIZE	d	D	L	L1	I	H1	H2	W
1/2"	.55	1.17	3.24	2.73	.87	2.42	1.68	1.48
3/4"	.78	1.48	3.71	3.43	1.00	3.04	2.11	1.67
1"	.98	1.76	4.13	3.90	1.12	3.63	2.54	2.22
1 1/4"	1.17	2.11	4.45	3.90	1.25	3.82	2.61	2.46
1 1/2"	1.40	2.42	5.07	4.25	1.37	4.49	3.04	2.93
2"	1.82	3.00	5.74	5.23	1.50	5.27	3.47	3.59
2 1/2"	2.34	3.59	7.96	6.94	1.75	6.24	4.10	4.29
3"	3.00	4.13	8.93	8.74	1.88	7.41	4.84	5.19
4"	3.94	5.27	11.70	10.76	2.25	9.09	5.77	6.63

Relations Between Temperature and Pressure

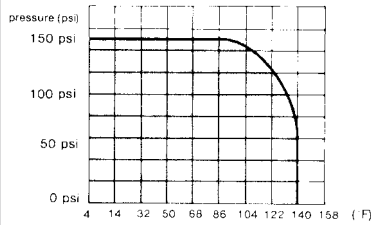

CV (GPM/(1 lbf/in²)^{1/2}) Opening Rate: 90°

SIZE	CV
1/2"	8.84
1"	25.24
1 1/4"	38.53
1 1/2"	51.28
2"	96.67
2 1/2"	162.37
3"	438.81
4"	865.90
CMIP-C Series excluded	

WITH EPDM SEATS

Threaded	Slip	Size	Ctn Qty	List Price
Part Number	Part Number			
HMIP50TE	HMIP50SE	1/2"	100	\$ 7.37
HMIP75TE	HMIP75SE	3/4"	100	9.48
HMIP100TE	HMIP100SE	1"	100	13.04
HMIP125TE	HMIP125SE	1 1/4"	100	18.40
HMIP150TE	HMIP150SE	1 1/2"	48	29.82
HMIP200TE	HMIP200SE	2"	24	39.45
HIMP250TE	HMIP250SE	2 1/2"	12	73.62
HMIP300TE	HMIP300SE	3"	12	127.58
HMIP400TE	HMIP400SE	4"	6	229.81

WITH PTFE SEATS

Threaded	Slip	Size	Ctn Qty	List Price
Part Number	Part Number			
HMIP50T	HMIP50S	1/2"	100	\$ 11.46
HMIP75T	HMIP75S	3/4"	100	15.40
HMIP100T	HMIP100S	1"	100	15.58
HMIP125T	HMIP125S	1 1/4"	100	24.68
HMIP150T	HMIP150S	1 1/2"	48	31.53
HMIP200T	HMIP200S	2"	24	42.99

Ball Valves - CPVC Sch 80 Molded-in-Place



ISO 9002

FLOWGUARD GOLD®
PIPE & FITTINGS

SCH 80 Series CPVC Molded-in-Place Ball Valve Features:

- Made with **Flo Guard Gold CPVC** material.
- Heavy duty thermoplastic CPVC construction for hot water use.
- NSF listed.
- Meets ASTM 2467 Schedule 80.
- CTS slip x slip - cream body, orange handle.
- PTFE seats providing excellent chemical resistance.
- EPDM O-Ring stem seal.
- Working pressure 75 PSI at 180°F.
- Maintenance free compact design.
- Severe shock loads & misalignment stress are absorbed by the valve body, not the ball & seat, minimizing the chance of uneven wear & leakage.
- Individually cartoned.
- Manufactured for AGI in an ISO 9002 facility.
- **Third party certified to NSF/ANSI 61&372.**

MATERIAL SPECIFICATIONS

Body	CPVC
Seat Seal	PTFE
Ball	CPVC
Stem Seal	EPDM
Handle	ABS
Bolt	Zinc Plated Steel
Cap	ABS

Relations Between Temperature and Pressure

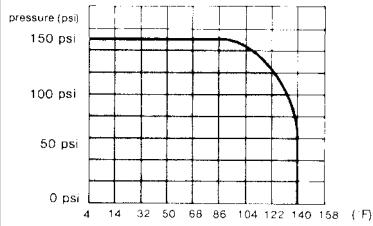

CV (GPM/(1 lbf/in²)^{1/2}) Opening Rate: 90"

SIZE	CV
1/2"	14.5
3/4"	29.5
1"	48.0

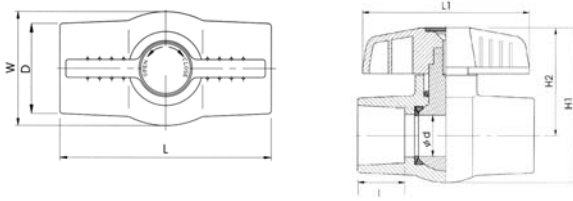

CMIP "C" Series CTS DIMENSIONS (IN.)

SIZE	d	D	L	L1	I	H1	H2	W
1/2"	.47	.94	2.65	2.34	.50	1.91	1.33	1.21
3/4"	.55	1.17	3.24	2.73	.87	2.42	1.68	1.48
1"	.78	1.48	3.71	3.43	.90	3.04	2.11	1.91

Part Number	Description	Ctn Qty	List Price
-------------	-------------	---------	------------

CPVC Ball Valve, Copper Tube Size, SLIP X SLIP

CMIP50C	1/2" SLIP X SLIP	100	\$ 10.34
CMIP75C	3/4" slip x slip	100	11.64
CMIP100C	1" slip x slip	100	18.11



VSGV Uni-Body



VSGV 3 piece body



VSGV 3 piece body
with union

PVC Slice Gate Valve Features:

- Designed for pool & spa, irrigation, plumbing, waste water and agricultural applications.
- Stainless steel shaft prevent rust and corrosion.
- Ozone & chemical resistant Santoprene™ materials.
- Santoprene™ seals are integrated to the paddle to eliminate any chance of torn or punctured gaskets.
- Maximum working pressure 50 psi (through 2").
- Solvent cement traps to catch excess glue.
- Every valve tested at double recommended working pressure.
- Valterra's patent pending triple o-ring neck seal to ensure against any chance of shaft leakage.



Unibody Design

- One piece uni-body design.
- Combination socket ID x spigot OD for installation flexibility.
- Locking handle provides positive shutt-off and easy gate opening.

3 Piece body

- Three piece configuration allows for repair or can be used as a union.
- Three piece configuration easily disassembles for inline service.

Part Number	Description	Max PSI	Ctn Qty	List Price
Uni-Body				
VSGV2101	1 1/2" slip x slip	45	30	\$ 26.19
VSGV2201	2" slip x slip	40	20	40.08
* Unibody 2" slip hubs are 2" slip or 2 1/2" spig				
Three Piece Body				
VSGV150SL	1 1/2" slip x slip	45	30	24.24
VSGV150FIPTXMIPT	1 1/2" fipt x mipt	45	40	32.28
VSGV150SLU	1 1/2" slip x union slip	45	38	39.55
VSGV150SD	1 1/2" step down pool hose x mipt ABS		40	28.93
VSGV200SL	2" slip x slip	40	20	37.79
VSGV200SP	2" slip x spigot	40	34	41.40
VSGV300SL	3" slip x slip	30	15	48.70
VSGV400SL	4" slip x slip w/ metal handle	20	6	207.06
VSGV600SL	6" slip x slip w/ stainless handle	10	1	862.62
VSGV800SL	8" slip x slip w/ stainless handle	10	1	1207.82
VSGV1000SL	10" slip x slip w/ stainless handle	10	1	2201.95
VSGV1200SL	12" slip x slip w/ stainless handle	10	1	2313.21



PVC Slice Gate Valve

- One piece "Uni-Body" PVC Construction. Guaranteed NO HUB LEAKS or loose bolts.
- 1/4 turn "Cam-Lock" for 100% shut-off..
- Internal "snap-lock" feature ensures valve will remain totally open, providing 100% flow with no restriction.
- Stainless steel shaft prevents rust and corrosion.
- Glass filled poly-pro tapered gate design for 100% sealing.
- Integrally molded seal on gate. - No pinched or torn gaskets.
- Seals are "Santoprene" that have been impregnated with a permanent lubricant. Never needs lube yet will provide continuous smooth operation. Ozone and chemical resistant for much longer life.
- Santoprene buttons on gate provides smooth operation without sticking.
- Every valve water tested at 100PSI and random quick burst tested at 400 PSI. Virtually no chance of leaky valves in the field at standard operating pressures.
- Maximum recommended operating pressure is 50 PSI.
- Glue wells on all slip-socket configuration catches excess glue during plumbing.
- Constructed and tested for use in pool & spa applications.
- Made in USA



SGV - SL Series



SGV-SP and SGV-SLU Series

Part Number	Size	Description	Ctn/Case Qty	List Price
SGV150SL	1 1/2"	Slip x Slip	14/56	\$ 31.48
SGV200SL	2"	Slip x Slip	12/48	33.29
SGV250SL	2 1/2"	Slip x Slip	5/20	70.60
SGV150SP	1 1/2"	Slip x Spigot	14/56	29.60
SGV200SP	2"	Slip x Spigot	12/48	33.29
SGV150SLU	1 1/2"	Slip x Slip with Union	10/40	50.94
SGV200SLU	2"	Slip x Slip with Union	10/40	61.76



MCRV Series

“CR” Full Flow Corrosion Resistant Check Valve Features:

- Protects heat exchangers from potential damage by inline chlorinators.
- Maintains full flow circulation system.
- Proprietary designed Hastelloy spring.
- Glass filled Noryl injection molded shaft.
- 100% silicone gasket never requires lubrication.
- Clear sight glass. Removable, servicable.
- 3 IPS sizes in one valve. 1 1/2” slip with bushing, 2” slip and 2 1/2” spigot. (1 1/2” bushing sold separately.)
- Spring loaded flapper/gate mechanism assures full flow and minimum cavitation.
- Positive water seal when in the closed position.
- “CR” valve can be installed in virtually any position.
- Use in highly corrosive conditions and conditions needing backflow prevention.

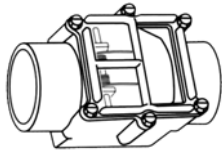

MCRV Series

Part Number	Description	Size	Ctn Qty	List Price
MCRV801-20H	PVC CR Swing Check Valve	2” Slip x Slip	12	\$ 135.42
60104028	CR Swing Check Bushing	2” Sp x 1 1/2” Slip	1	5.79



Bushing

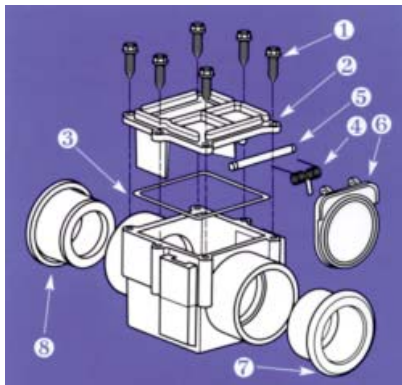

CR VALVE REPLACEMENT PARTS

ID	Part Number	Description	Ctn Qty	List Price
1	M04030066	#14 x 1” Phillips Pan Head SS Screw	6	\$ POR
4	M0405001	Spring	1	POR
5	M0401005P	Shaft	1	POR
6	M0081201020	Gate Assembly	1	POR
7	M0060504028	Adapter 2” sp x 1 1/2” Slip, Black	1	POR
8	M0060104028	Adapter, 2” sp x 1 1/2” Slip, White	1	POR

Check Valves - PVC Swing



MCV Series



“Smart” Swing Check Valve Features:

- Patented innovation in swing check valve technology eliminates in-line flow restriction of conventional check valves.
- Spring loaded swing check flapper/gate allows full flow and reliable back flow prevention.
- Standard “smart” check valve remains closed to 1/2 psi, then open for full flow.
- Magnetic “smart” check valves remain closed to 2 psi, then open for full flow.

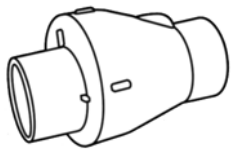

MCV821 Series

Part Number	Size	Description	Spring Tension	Ctn Qty	List Price
MCV821-10	1"	Slip x Slip	1/2 lb.	12	\$ 30.49
MCV821-10C	1"	Slip x Slip CLEAR	1/2 lb.	12	34.81
MCV821-15	1 1/2"	Slip x Slip	1/2 lb.	12	46.02
MCV821-15C	1 1/2"	Slip x Slip CLEAR	1/2 lb.	12	50.81
MCV821-20	2"	Slip x Slip	1/2 lb.	12	54.14
MCV821-20C	2"	Slip x Slip CLEAR	1/2 lb.	12	58.41
MCV821-20M	2"	Slip x Slip w/magnet	2 lb.	12	59.13
MCV821-20MC	2"	Slip x Slip w/magnet CLEAR	2 lb.	12	63.47

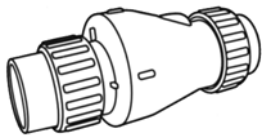

MCV823 Series

MCV823-10	1"	Union x Union	1/2 lb.	12	46.02
MCV823-10C	1"	Union x Union CLEAR	1/2 lb.	12	50.81
MCV823-15	1 1/2"	Union x Union	1/2 lb.	12	56.71
MCV823-15C	1 1/2"	Union x Union CLEAR	1/2 lb.	12	64.90
MCV823-20	2"	Union x Union	1/2 lb.	12	72.11
MCV823-20C	2"	Union x Union CLEAR	1/2 lb.	12	81.96
MCV823-20M	2"	Union x Union w/magnet	2 lb.	12	82.87
MCV823-20MC	2"	Union x Union w/magnet CLEAR	2 lb.	12	87.64



MCV850 Series

MCV850-15	1 1/2"	Check/Slice Combo Union x Slip		12	88.77
MCV850-20	2"	Check/Slice Combo Union x Slip		12	113.94



Float Valves - Bronze, NO LEAD Bronze



Bronze, NO LEAD Bronze Float Valve Features:

- Cast bronze or NO LEAD bronze body
- Buna-N Disc
- Heavy Duty
- Tapped for 1/4"-20SAE rod
- Threaded outlet
- Rated at 125 psi
- **Third party certified to NSF/ANSI 372.**



BFV Series

Part Number	Size	Inlet	Outlet	Tapped	Ctn Qty	List Price
BFVNL1/2	1/2"	1/2" mpt	1/2" mpt	1/4"-20SAE	10/100	\$ 62.12
BFVNL3/4	3/4"	3/4" mpt	3/4" mpt	1/4"-20SAE	10/80	69.14
BFVNL1	1"	1" mpt	1" mpt	1/4"-20SAE	10/40	108.03

Stainless Steel Rods Features:

- Stainless Steel SAE
- Male thread both ends
- **Third party certified to NSF/ANSI 372.**



BFVR Series

Part Number	Length	Thread	Fits Valve Size	Ctn Qty	List Price
BFVR8	8"	1/4"-20SAE	1/2" - 1"	50/400	\$ 8.28
BFVR10	10"	1/4"-20SAE	1/2" - 1"	50/300	9.59
BFVR12	12"	1/4"-20SAE	1/2" - 1"	50/300	10.74

Plastic Float Features:

- PVC, Corrosion resistant.
- Lightweight
- Up to 175°F
- For open tank service only
- Bronze or NO LEAD bronze threaded connection.
- **Third party certified to NSF/ANSI 372.**



BFVFP Series

Part Number	Float Diam.	Buoyancy	Female Connection	Ctn Qty	List Price
BFVFPNL5	5"	2.17 lbs.	1/4"-20SAE	100	\$ 30.16
BFVFPNL6	6"	3.8 lbs.	1/4"-20SAE	100	37.40
BFVFPNL8	8"	9.87 lbs.	1/4"-20SAE	20	66.45



HBFV Series

Ductile Iron Butterfly Valve Features:

- Designed for swimming pool, irrigation and water systems.
- Wafer body features 4 alignment holes.
- Lever lock handle (spring loaded) provides excellent manual control for balancing or shut off services.
- Notched throttling plate allows balancing in 10° increments in any position desired within 90° arc rotation of the disc.
- Positive bubble-tight shutoff with minimum torque.
- Seat face eliminates need for flange gaskets.
- Phenolic backed seats prevent collapse, are stretch resistant, blowout proof and field replaceable.
- **EPDM seats** temperature rated at -30°F to 275°F.
- 420 stainless steel shaft
- Bidirectional dead-end capability for 250 psi (2" - 12").
- Compatible with ANSI 125/150 flanges.
- Designed to comply with MSS SP-67 and API 609.
- **Ductile iron, ENP plated** disc.
- Third party certified no-lead.
- Imported



HBFV GEAR Series

Part No.	Size	Weight(lbs)	Ctn Qty	List Price
Ductile Iron ENP Plated Disc				
HBFV2	2"	7	1	\$ 142.72
HBFV2 1/2	2-1/2"	8	1	150.80
HBFV3	3"	10	1	185.08
HBFV4	4"	12	1	274.43
HBFV5	5"	15.5	1	295.99
HBFV6	6"	17.5	1	408.45
HBFV8	8"	33	1	696.58
HBFV10	10"	50	1	1031.21
HBFV12	12"	74	1	1413.64
Ductile Iron ENP Plated Disc - GEAR DRIVE				
HBFV6-GEAR	6"	28.5	1	448.69
HBFV8 GEAR	8"	54	1	697.08

Flanges & Bolt kits available, see page P.28

Butterfly Valves - Ductile Iron

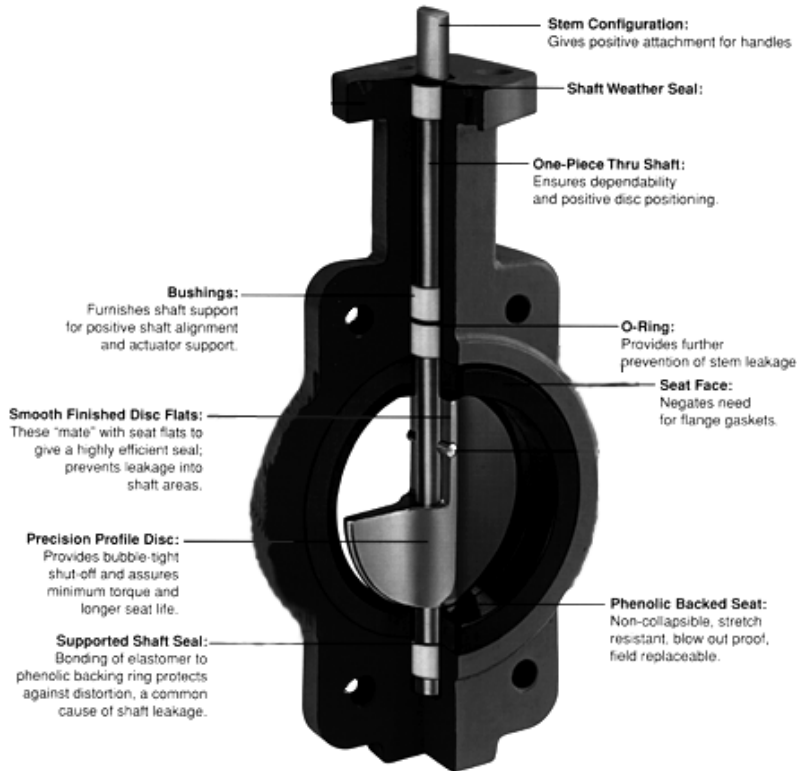

MATERIAL SPECIFICATIONS

No.	Part	Material
1	Body	DUCTILE Iron
2	Disc	Ductile Iron
3	Seat	EPDM
4	Shaft	420 Stainless Steel
5	Key	Carbon Steel
6	O-ring	EPDM
7-9	Bushing	Nylon

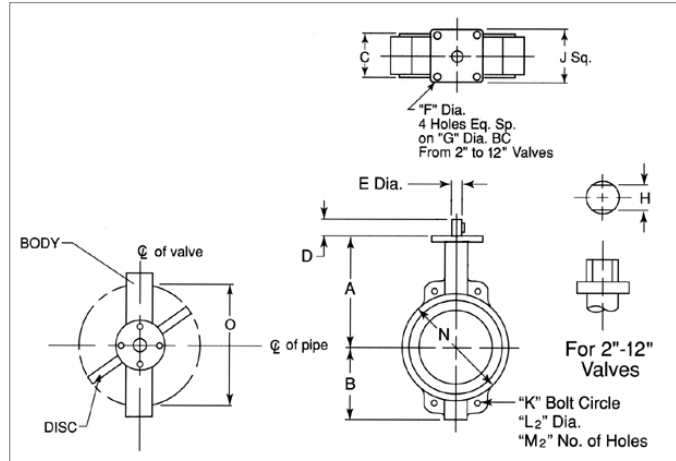
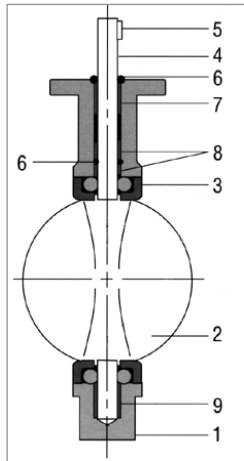

SIZE \ DIMENSION (in) for HBFV Series

	A	B	C	D	E	F	G	H	J	K	L2	M2	N	O
2"	5.51	2.44	1.64	1.26	.50	.375	2.76	.39	2.75	4.75	.75	4	4.75	2.12
2 1/2"	6.02	2.76	1.75	1.26	.50	.375	2.76	.39	2.75	5.5	.75	4	5.50	2.57
3"	6.26	2.89	1.75	1.26	.50	.375	2.76	.39	2.75	6.0	.75	4	6.00	3.14
4"	7.01	4.49	2.00	1.26	.625	.375	2.76	.47	2.75	7.50	.75	4	7.50	4.13
5"	7.50	4.79	2.13	1.26	.75	.375	2.76	.55	2.75	8.50	.87	4	8.50	5.12
6"	8.01	5.55	2.12	1.26	.75	.375	2.76	.55	2.75	9.50	.87	4	9.50	6.13
8"	9.50	6.85	2.50	1.26	.875	.438	4.02	.67	3.75	11.75	.87	4	11.75	8.15
10"	10.75	8.19	2.50	1.58	1.125	.438	4.02	.87	3.75	14.25	1.00	4	14.29	9.98
12"	12.25	9.53	2.99	1.58	1.125	.438	4.02	.95	3.75	17.00	1.00	4	17.00	11.89



PBFV Series

ISO 9002



MATERIAL SPECIFICATIONS

No.	Part	Material	Qty
1	Body	PVC	1
2	Disc	PP	1
3	Seat Seal	EPDM	1
4	Stem	SS 410	1
5	O-ring	EPDM	2
6	O-ring	EPDM	2
7	Inserted Nut	SS 41	3
8	Large Handle	ABS	1
9	Small Handle	ABS	1
10	Spring Lock	ABS	1
11	Handle Insert	SS	1
12	Handle Lever	SS 304	1
13	Spring	SS 304	1
14	Spring Pin	SS 304	1
15	Spring Pin	SS 304	1
16	Washer	SS 304	1
17	Locking Plate	SS 304	1
18	Gear Seat	PP + GF	1
19	Washer	SS 304	1
20	Bolt	SS 304	3
21	Nut	PVC	1
22	Insert Nut	C3604	1
23	Level	SS 304	1
24	Rivet	SS	2

CV (GPM/(1 lbf/in²)^{1/2})
Opening Rate: 90°

SIZE	CV
2"	100.87
2 1/2"	137.82
3"	224.08
4"	409.51
5"	523.92
6"	1243.00

PVC Sch 80 Butterfly Valves Features:

- 150 PSI working pressure.
- PVC body, polypropylene disc, and EPDM seat and o-ring.
- Flanged end design.
- Corrosion resistant.
- Excellent flow characteristics.
- Ideally suited for flow control in a minimum piping space.
- Clear indication of disc opening degree.
- Built in seat requires no additional gaskets between flanges.
- Manufactured for AGI in an ISO 9002 facility.
- Imported.

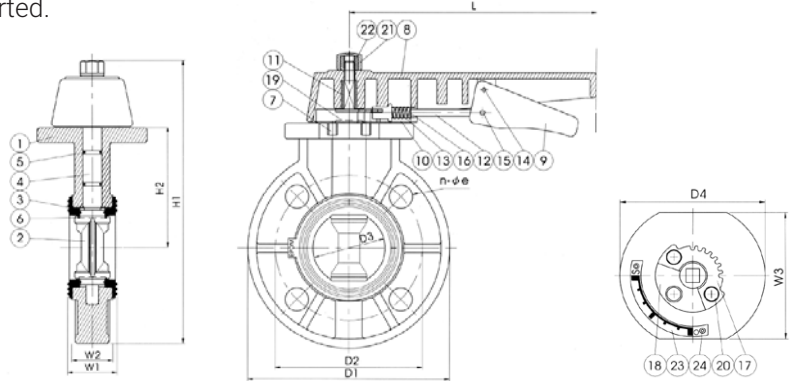

DIMENSIONS \ SIZE (in)

	2"	2 1/2"	3"	4"	5"	6"	8"
D1	6.44	7.22	7.80	8.93	9.98	11.12	13.38
D2	4.70	5.44	5.94	7.43	8.42	9.42	11.64
D3	2.20	2.71	3.10	4.01	5.11	6.02	7.91
D4	4.13	4.66	4.84	5.26	6.40	6.64	7.84
L	7.92	7.92	7.92	9.91	11.86	11.86	11.86
H1	9.59	10.37	10.76	12.40	15.21	15.80	18.17
H2	4.02	4.41	4.49	5.27	5.85	6.90	8.19
W1	1.67	1.85	1.85	2.23	2.57	2.88	3.41
W2	1.35	1.45	1.45	1.83	2.22	2.53	3.06
W3	3.67	3.67	3.66	3.89	4.31	3.93	4.76
n-oe	.741	.741	.741	.741	.858	.858	.858

Part Number	Description	Ctn Qty	List Price
PBFV2	2" PVC Butterfly valve	4	\$ 306.50
PBFV21/2	2 1/2" PVC Butterfly valve	4	313.98
PBFV3	3" PVC Butterfly valve	4	309.45
PBFV4	4" PVC Butterfly valve	4	352.64
PBFV5	5" PVC Butterfly valve	4	508.55
PBFV6	6" PVC Butterfly valve	4	589.99
PBFV8	8" PVC Butterfly valve	1	860.61

Replacement handles

PBFV2 HANDLE	2" PVC valve handle	1	34.03
PBFV21/2 HANDLE	2 1/2" PVC valve handle	1	34.03
PBFV3 HANDLE	3" PVC valve handle	1	34.03
PBFV4 HANDLE	4" PVC valve handle	1	42.09
PBFV5 HANDLE	5" PVC valve handle	1	56.52
PBFV6 HANDLE	6" PVC valve handle	1	57.12
PBFV8 HANDLE	8" PVC valve handle	1	57.12

Flanges, Bolt Kits, Gaskets

PVC Sch 80 Van Stone Flange Features:

- Two-piece van stone socket style.
- Class 150, Schedule 80
- Improve the security and safety of connections between pipes, valves & fittings.
- Imported - Manufactured for AGI in an ISO 9002 facility.



PF Series

ISO 9002



	DIMENSIONS \ SIZE (in)						
	2"	3"	4"	6"	8"	10"	12"
D1	5.93	7.49	8.93	11.08	13.38	15.83	18.76
D2	4.72	5.93	7.45	9.40	11.62	14.12	16.85
D3	2.96	4.21	5.19	7.45	9.28	12.09	14.20
d	1.99	3.00	3.98	6.08	7.96	9.98	11.97
d1	2.35	3.46	4.45	6.55	8.53	10.64	12.62
d2	2.37	3.48	4.48	6.59	8.57	10.68	12.67
H	1.68	2.11	2.50	3.32	4.60	5.85	7.45
T	.78	1.01	1.09	1.25	1.40	1.64	1.64
l	1.49	1.86	2.23	2.97	3.98	4.80	6.44
n-oe	.741	.741	.741	.858	.858	.936	.975

Part Number	Description	Ctn Qty	List Price
PF2	2" Flange	60	\$ 21.07
PF2 1/2	2 1/2" Flange	36	32.53
PF3	3" Flange	30	35.94
PF4	4" Flange	20	45.45
PF6	6" Flange	10	71.51
PF8	8" Flange	4	116.46
PF10	10" Flange	2	216.98
PF12	12" Flange	2	233.94

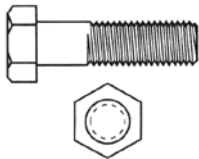
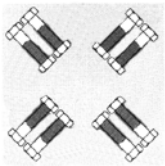

BBK Series

Bolt Kit Features:

- For use with cast iron & PVC butterfly valves. BF8200, HBFV and PBFV Series
- ASTM-A307 grade zinc plated carbon steel bolts and A563 finished nuts.
- Washers and Gaskets NOT included- Available upon request.

Part Number	Valve Size	Bolt Size	Bolts/Kit	Ctn Qty	List Price
BBK2	2"	5/8" x 5"	4	16	\$ 35.28
BBK2.5/3	2 1/2" and 3"	5/8" x 5 1/2"	4	16	35.19
BBK4	4"	5/8" x 6"	8	8	65.71
BBK5/6	5" and 6"	3/4" x 6 1/2"	8	8	97.20
BBK8	8"	3/4" x 7"	8	8	126.52
BBK10	10"	7/8" x 7 1/2"	12	3	276.74
BBK12	12"	7/8" x 8 1/2"	12	3	325.68

Red Rubber Gasket Features:

- For use with butterfly valves, Sch 80 flanges
- Red rubber, 150 lbs., 1/8" full face.



GSK Series

Part Number	Valve Size	List Price	Part Number	Valve Size	List Price
GSK11/2R	1 1/2"	\$ 32.19	GSK5R	5"	\$ 57.50
GSK2R	2"	23.33	GSK6R	6"	36.34
GSK2 1/2R	2 1/2"	28.70	GSK8R	8"	52.73
GSK3R	3"	35.70	GSK10R	10"	66.48
GSK4R	4"	34.79	GSK12R	12"	112.01

Butterfly Valve Installation Kit Features:

- Everything needed for a quick, easy butterfly valve installation.
- Available with PVC Sch 80 or Ductile Iron butterfly valves.
- Custom kits available upon request.



PBVIK Series



PVC Butterfly Valve Installation Kit Includes:

- One PBFV Series PVC Sch 80 Butterfly valve.
- Two PF Series PVC Sch 80 Van Stone flanges.
- Two red rubber GSK gaskets.
- Bolt kit with steel nuts and bolts.
- Steel washers.

Part Number	Size	Number of Nuts/Bolts	Number of Washers	Ctn Qty	List Price
PBVIK2	2" Kit	4	8	1	\$ 325.49
PBVIK2 1/2	2 1/2" Kit	4	8	1	375.95
PBVIK3	3" Kit	4	8	1	428.70
PBVIK4	4" Kit	8	16	1	541.38
PBVIK6	6" Kit	8	16	1	895.37
PBVIK8	8" Kit	8	16	1	1206.14



PHBFV Series



Ductile Iron Butterfly Valve Installation Kit Includes:

- One HBFV Series Ductile Iron Butterfly valve.
- Two PF Series PVC Sch 80 Van Stone flanges.
- Bolt kit with steel nuts and bolts.
- Steel washers.
- Rubber gaskets NOT included. (Extended EPDM seat on the HBFV valve acts as gasket seal with flange.)

Part Number	Size	Number of Nuts/Bolts	Number of Washers	Ctn Qty	List Price
PHBFV2NG	2" Kit	4	8	1	\$ 214.82
PHBFV3NG	3" Kit	4	8	1	242.00
PHBFV4NG	4" Kit	4	8	1	383.51
PHBFV6NG	6" Kit	4	8	1	530.99
PHBFV12NG	12" Kit	4	8	1 *	1958.71

* Shipped in two cartons





Clear Braided PVC Hose Standard Wall, Class 125 Features:



- Flexible, see through clear hose with braid pattern reinforcement of two polyester spirals.
- Flexible clear PVC NSF 51 certified to 100°F (38°C), USP CLASS V1 rated.
- All hose compound ingredients used are listed in US FDA CFR, Title 21.
- Temperature range + 25° to 150° F / -5° to +65°C.
- Silicone free.
- Food and beverage grade, standard wall.
- Use for air, water lines.

Part Number	Nominal (inches)		Max Working Pressure		Reel Length	Approx Wt per CFT.	List Price Per Reel
	ID	OD	PSI@68°F	PSI@122°F			
CBH25-1	1/4	0.438	250	105	100'	5.7 lbs	\$ 159.47
CBH38-1	3/8	0.594	225	97	100'	9.0 lbs	222.25
CBH50-1	1/2	0.750	200	86	100'	13.8 lbs	305.16
CBH58-1	5/8	0.875	200	86	100'	16.5 lbs	363.39
CBH75-1	3/4	1.030	150	65	100'	21.9 lbs	457.68
CBH100-1	1	1.300	125	54	100'	31.5 lbs	568.16
CBH100-2	1	1.300	125	54	200'	31.5 lbs	1061.98
CBH125-50	1 1/4	1.625	100	43	50'	45.0 lbs	559.55
CBH125-1	1 1/4	1.625	100	43	100'	45.0 lbs	1119.14
CBH150-50	1 1/2	1.937	100	43	50'	64.0 lbs	711.96
CBH150-1	1 1/2	1.937	100	43	100'	64.0 lbs	1423.86
CBH200-1	2	2.490	75	33	100'	95.0 lbs	2284.55

**** Temperatures higher than 68° F reduce available working pressure. See next page for temperature, working pressure calculation chart and cautionary note.**

Effects of Elevated Temperatures on Thermoplastic Hose.

The compounds used in clear braided PVC hose are generally referred to as thermoplastics. These materials achieve their optimum physical properties at room temperature, 68°F (20°C). As these materials are exposed to increased ambient temperatures, they will soften and their physical properties will change. This will have the effect of sharply reducing the available working pressure. Coupling retention will also be reduced. The charts below illustrate this effect. In all cases, the product should be tested in a controlled, secure and safe environment, and all operating conditions should be considered prior to use.

All published working pressures of AGI Series CBH hose are based on a room temperature of 68°F (20°C).

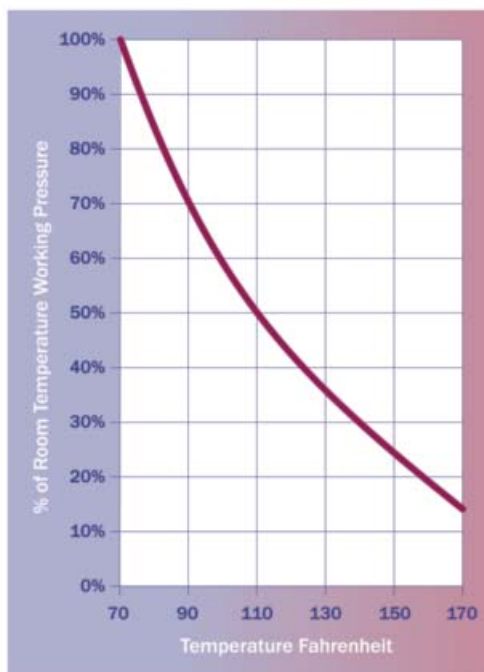

Example from the Fahrenheit Chart

If working pressure at 68°F is 200 psi, then the WP at 110°F is 200 x 50%, or 100 psi

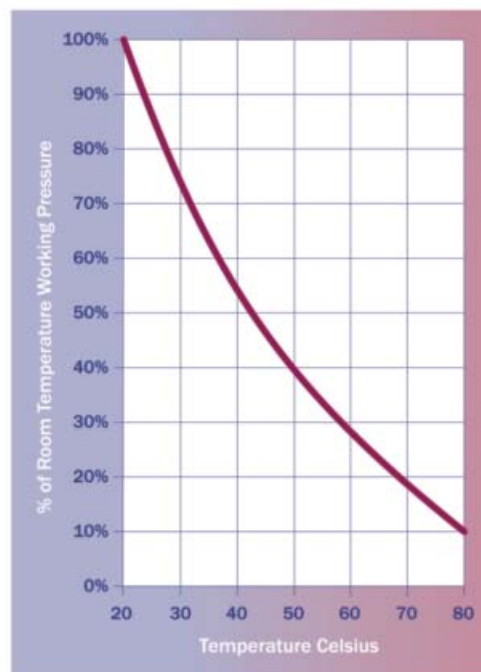

Example from the Celsius Chart

If working pressure at 20° is 14 bar, then the WP at 50°C is 14 x 50%, or 5.6 bar

CAUTIONARY NOTE

The charts are to be used as a guideline only. The information and recommendations contained here are, to the best of our manufacturer's knowledge, accurate and reliable, but no guarantee of their accuracy is made. All products are sold upon the condition that purchasers shall make their own tests to determine the suitability of such products for their particular purposes and uses, and purchasers assume all risks and liability for the results of use of the products, including use in accordance with seller's recommendations. Variability in length of exposure, temperature, pressure, velocity of fluid, and chemical concentration all contribute to reduced working pressure and hose reliability.



Polyethylene Tubing Features:

- Conforms to FDA, NSF and USDA Standards.
- Temperature Range -100° F to +140° F
- Economical.
- Extremely Flexible.
- Translucent.
- Resists Corrosion.
- **NOT FOR USE WITH HOT WATER**



- **SOLD IN COIL LENGTHS ONLY.**
- ORDER BY THE NUMBER COIL LENGTHS REQUIRED.
Ex: For 500' of MV4040-5 order Qty 1 MV4040-5

Part Number Bulk Boxed	Part Number Dispenser Box	OD	ID	Wall Thickness	Max PSI @ 70°F	Coil Length	List Price Per Coil
MV4040-1BLACK		1/4"	.17"	0.04"	135	100'	\$ 40.62
MV4040-1		1/4"	.17"	0.04"	135	100'	40.30
MV4040-5		1/4"	.17"	0.04"	135	500'	201.57
MV4040M		1/4"	.17"	0.04"	135	1000'	403.14
MV4062-1		1/4"	1/8"(.125)	1/16"(.062)	180	100'	45.79
MV4062-5		1/4"	1/8"(.125)	1/16"(.062)	180	500'	229.00
MV4062M		1/4"	1/8"(.125)	1/16"(.062)	180	1000'	458.00
MV5062-1		5/16"	3/16"(.1875)	1/16"(.062)	140	100'	60.37
MV5062-5		5/16"	3/16"(.1875)	1/16"(.062)	140	500'	301.81
MV5062M		5/16"	3/16"(.1875)	1/16"(.062)	140	1000'	603.65
MV6062-1		3/8"	1/4"(.250)	1/16"(.062)	120	100'	75.16
MV6062-5		3/8"	1/4"(.250)	1/16"(.062)	120	500'	385.53
MV6062-5BLACK		3/8"	1/4"(.250)	1/16"(.062)	120	500'	376.79
MV6062M		3/8"	1/4"(.250)	1/16"(.062)	120	1000'	766.84
MV8062-1		1/2"	3/8"(.375)	1/16"(.062)	90	100'	108.57
MV8062-5		1/2"	3/8"(.375)	1/16"(.062)	90	500'	542.86
MV10062-1		5/8"	1/2"(.500)	1/16"(.062)	70	100'	133.86
MV10062-5		5/8"	1/2"(.500)	1/16"(.062)	70	500'	669.45
MV12075-1		3/4"	.6	.075	60	100'	183.18
MV16093-1		1"	.814	3/32" (.094)	55	100'	299.14
	TP309	5/16"	3/16"(.1875)	1/16"(.062)		100'	75.57



POLYETHYLENE TUBING SIZING GUIDE

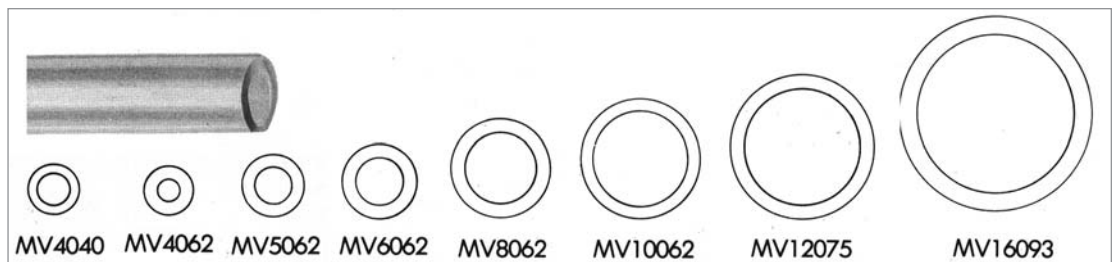

Tubing - Clear Vinyl



Vinyl Tubing Features:

- Temperature Range -20° F to +150° F
- Flexible.
- Transparent.
- Tasteless.
- Non-Toxic.
- **NOT FOR USE WITH HOT WATER**



Applications:

- Pool slides
- RV use cold water
- Water softeners
- Ice maker
- Livestock
- Food & Beverage

• **SOLD IN COIL LENGTHS ONLY.**
 • ORDER BY THE NUMBER COIL LENGTHS REQUIRED.
 Ex: For 500' of IV7062-5 order Qty 1 IV7062-5

Part Number	Bulk Box	Dispenser Box	OD	ID	Wall Thickness	Length	List Price Per Coil
IV4062-1			1/4"	1/8"(.125)	1/16"(.062)	100'	\$ 73.33
IV5062-1			5/16"	3/16"(.1875)	1/16"(.062)	100'	93.37
IV6062-1			3/8"	1/4"(.250)	1/16"(.062)	100'	115.72
IV7062-1			7/16"	5/16"(.3125)	1/16"(.062)	100'	117.23
IV8062-1			1/2"	3/8"(.375)	1/16"(.062)	100'	148.49
IV10062-1			5/8"	1/2"(.500)	1/16"(.062)	100'	197.90
TV309			5/16"	3/16"(.1875)	1/16"(.062)	100'	63.17



VINYL TUBING SIZING GUIDE

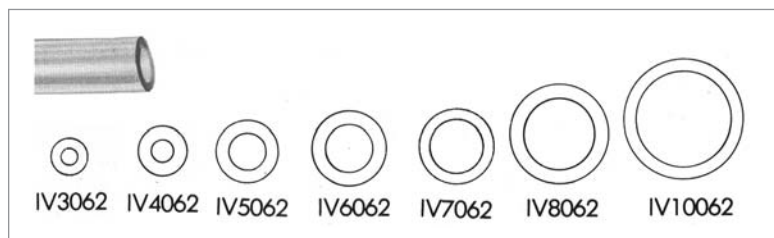



Barb Fitting Features:

- Superior NO LEAD brass fittings for soft plastic tubing for oil, water, air, vacuum, gas and liquid low pressure lines.
- Exclusive self-clinching double barbs actually tighten under strain.

Compression Fitting Features:

- NO LEAD Brass compression fittings designed for plastic tubing.
- Built-in tube support prevents tube collapse and allows easy assembly.



VT22

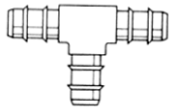

VT224

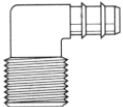

VT229

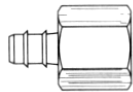

VT26

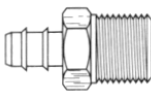

VT28

Part Number	Fits Tube OD	Fits Tube ID	Thread Size	Qty	List Price
Coupling (Ins x Ins)					
VT22-4-4NL	3/8"	1/4"		Bulk	\$ 6.24
VT22-6-6NL	1/2"	3/8"		Bulk	7.69
Tee (Ins x Ins x Ins)					
VT224-6NL	1/2"	3/8"		Bulk	19.41
Elbow (Ins x MIP)					
VT229-4-4NL	3/8"	1/4"	1/4" mip	Bulk	17.73
VT229-6-4NL	1/2"	3/8"	1/4" mip	Bulk	15.60
Female Adapter (Ins x FIP)					
VT26-6-4NL	1/2"	3/8"	1/4" fip	Bulk	10.14
Male Adapter (Ins x MIP)					
VT28-4-2NL	3/8"	1/4"	1/8" mip	Bulk	5.84
VT28-4-4NL	3/8"	1/4"	1/4" mip	Bulk	8.31
VT28-6-4NL	1/2"	3/8"	1/4" mip	Bulk	9.52

Fittings for Plastic Tubing - NL Brass

VT62

Part Number	Fits Tube OD	Fits Tube ID	Thread Size	Qty	List Price
Union w/ inserts (Comp x Comp)					
VT62-4NL	1/4" x 1/4"	.17"		Bulk	\$ 12.41

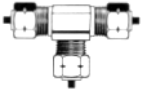
VT64

Tee w/ inserts (Comp x Comp x Comp)					
VT64-4NL	1/4" x 1/4" x 1/4"	.17"		Bulk	21.36

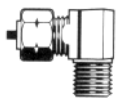
VT69

Male Elbow w/ inserts (Com x MIP)					
VT69-4-4NL	1/4"	.17"	1/4" mip	Bulk	19.87

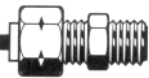
VT69

Male Connector w/ inserts (Comp x MIP)					
VT68-4-4NL	1/4"	.17"	1/4" mip	Bulk	10.45
VT68-6-4NL	3/8"	1/4"	1/4" mip	Bulk	12.09

VT68

Delrin Sleeve					
VT60-4	1/4"			Bulk	0.63
VT60-6	3/8"			Bulk	1.04

VT60

Nut					
VT61-4NL	1/4"			Bulk	2.09
VT61-5NL	5/16"			Bulk	2.71
VT61-6NL	3/8"			Bulk	3.02

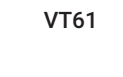
VT61

Tube Support					
VT63-4NL	1/4"	.17"		Bulk	0.77
VT63-6NL	3/8"	1/4"		Bulk	1.43

VT63



T Series

HARVARD CONTRACTOR'S Plastic Pipe & Hose Cutter Features:

- Heavy duty, glass reinforced nylon handles.
- Handles designed with matted surface and finger indentation for firm gripping in any weather conditions.
- Handle "bridge" support structure designed to eliminate deflection, bending or breaking while cutting for straighter, truer cut every time.
- "100" and "135" available in black or yellow. "200" available in black.
- Available with either PTFE coated hardened tool steel or polished high-carbon stainless steel blades specially honed to maintain their edge longer than competitive blades.
- Cutter blades individually laser etched with "100", "135" or "200" for easy identification. Replacement blades are blister packed with knock out pin.
- All Harvard Plastic Pipe and Hose cutters are blister packed with an attractive hang-up card.



The unique cutting action of the Harvard Contractor's cutter is produced by slightly rotating or rocking the cutter on the pipe while squeezing lightly on the handles. After just a few cuts, anyone can make fast, clean, straight cuts. The rotating action is not necessary for rubber hose or soft tubing (except when cutting 2" or larger hose with the SS200).



Part Number	Color	Blade Material	Cuts	Ctn Qty	List Price
HARVARD CONTRACTOR Pipe & Hose Cutters					
T100	Black	PTFE Coated Hardened Steel	PE, Rubber hose & PVC (Class & Sch 40) through 1"	50	\$ 31.43
YT100	Yellow	PTFE Coated Hardened Steel	PE, Rubber hose & PVC (Class & Sch 40) through 1"	50	31.43
T100SS	Black	Stainless Steel	PE, Rubber hose & PVC (Class & Sch 40) through 1"	50	32.81
YT100SS	Yellow	Stainless Steel	PE, Rubber hose & PVC (Class & Sch 40) through 1"	50	32.81
T135	Black	PTFE Coated Hardened Steel	PE, Rubber hose through 1 1/2" Class PVC through 1 1/4"	50	35.27
YT135	Yellow	PTFE Coated Hardened Steel	PE, Rubber hose through 1 1/2" Class PVC through 1 1/4"	50	35.27
T135SS	Black	Stainless Steel	PE, Rubber hose through 1 1/2" Class PVC through 1 1/4"	50	36.63
YT135SS	Yellow	Stainless Steel	PE, Rubber hose through 1 1/2" Class PVC through 1 1/4"	50	36.63
SS200	Black	Stainless Steel	Rubber hose through 2" PE through 1 1/2" & Class PVC through 1 1/4"	50	38.85

HARVARD CONTRACTOR Replacement Blades (includes 1 knock out pin) DP DOUBLE PACK

BT100	PTFE Coated Hardened Steel Blade	T100, YT100	100	14.25
BT100SS	Stainless Steel Blade	T100SS, YT100SS	100	13.32
BT135	PTFE Coated Hardened Steel Blade	T135, YT135	100	16.26
BT135DP	PTFE Coated Hardened Steel Blades (2)	T135, YT135	100	29.66
BT135SS	Stainless Steel Blade	T135SS, YT135SS	100	14.95
BT135DPSS	Stainless Steel Blades (2)	T135SS, YT135SS	100	31.63
SSB200	Stainless Steel Blade	SS200	50	18.08

Pipe & Hose, PVC - Ratchet Pipe Cutters



APC100SS

HARVARD CONTRACTOR'S Plastic Pipe & Hose Cutter with Spring Action Features:

- Heavy duty, cast metal handles.
- Handles designed with matted surface and finger indentation for firm gripping in any weather conditions.
- Spring action for easy use.
- Latch handle for carrying in closed position.
- **Reversible**, replaceable polished high carbon stainless steel blades honed to maintain thin edge longer than competitive blades.
- Cuts PE, Rubber hose & PVC (Class & Sch 40) through 1" ID (max diameter 1 3/8")
- Blister packed with an attractive hang-up card.



The unique cutting action of the Harvard Contractor's cutter is produced by slightly rotating or rocking the cutter on the pipe while squeezing lightly on the handles. After just a few cuts, anyone can make fast, clean, straight cuts. The rotating action is not necessary for rubber hose or soft tubing.



Part Number	Color	Blade Material	Cuts	Ctn Qty	List Price
HARVARD CONTRACTOR Pipe & Hose Cutters					
APC100SS	Red	Stainless Steel	PE, Rubber hose & PVC through 1" ID	50	\$ 28.59
HARVARD CONTRACTOR Replacement, Reversible Blade					
APC100SSB		Stainless Steel reversible blade		1	14.33



HS25

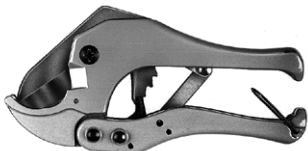

HM42



HL48



HL50

HARVARD® PVC Ratchet Pipe Cutter Features:

- For use on plastic pipes up to 1", 1 1/4", 1 3/8", 1 1/2" or 2" diameter.
- **Blade and ratchet teeth made of molybdenum vanadium stainless steel. Stays sharp longer than plated steel blades.**
- All metal construction insures long life; locking clip provides safe storage.
- Holds pipe as it cuts, creating smooth, even ends.
- One hand operation (except on HL50).

Part Number	Description	Ctn Qty	List Price
Cutters - With molybdenum vanadium stainless steel blades			
HS25	PVC Pipe Cutter, 1"	60	\$ 76.11
HM42	PVC Pipe Cutter, 1-1/4"	60	77.15
HL42A	PVC Pipe Cutter, 1 3/8"	60	107.09
HL48	PVC Pipe Cutter, 1 1/2"	40	158.21
HL50	PVC Pipe Cutter, 2"	20	308.58
Replacement Blades - Molybdenum vanadium stainless steel			
HS25B	Blade for HS25	1	35.97
HM42B	Blade for HM42	1	48.64
HL42AB	Blade for HL42A	1	56.10
HL48B	Blade for HL48	1	83.20
HL50B	Blade for HL50	1	160.00
Replacement Spring Sets			
HS25SP	Spring Set for HS25	1	5.40
HM42SP	Spring Set for HM42	1	7.36
HL42ASP	Spring Set for HL42A	1	7.57
HL48SP	Spring Set for HL48	1	12.19
HL50SP	Spring Set for HL50	1	8.17

HRPC42

HRPC50

HARVARD CONTRACTOR'S PVC Ratchet Pipe Cutter

Features:

- For use up to 1 1/4" or 2" diameter pipe.
- All stainless steel cutting blade and ratchet teeth.
- All metal body construction with latching handle for safe storage.
- 1 1/4" cutter has quick release thumb lever for easy blade opening.
- 1 1/4" cutter packaged in blister card for easy display.
- 2" two hand cutter has rubber handle grips.
- 2" two hand cutter packaged with wrap around card for easy display.
- Replacement stainless steel blades and spring sets are available.



Part Number	Description	Ctn Qty	List Price
-------------	-------------	---------	------------

Cutters - with stainless steel blade

HRPC42	PVC Pipe Cutter, 1 1/4"	50	\$ 68.56
HRPC50	PVC Pipe Cutter, 2"	10	228.94

Replacement Blades - stainless steel

HRPC42B	Blade for HRPC42	1	15.20
HRPC50B	Blade for HRPC50	1	114.33

Replacement Spring Sets

HRPC42SP	Spring Set for HRPC42	1	2.49
HRPC50SP	Spring Set for HRPC50	1	2.49



HARVARD CONTRACTOR'S One Hand 2" PVC Ratchet Pipe Cutter Features:

- Cuts PVC, POLY, ABS, CPVC and PEX pipe.
- **One hand** ratchet operation.
- Latch handle with rubber handle grip.
- All stainless steel blade.
- Teal colored die cast aluminum body.
- Max pipe O.D. 2.48" (63mm)
- HRPC63B Replacement blade available.



Part Number	Description	Ctn Qty	List Price
-------------	-------------	---------	------------

Cutters - with stainless steel blade

HRPC63	PVC One Hand Pipe Cutter, 2"	20	\$ 137.33
--------	------------------------------	----	------------------

Replacement Blades - stainless steel

HRPC63B	Blade for HRPC63	30	85.66
---------	------------------	----	--------------

Replacement Pin and screw

HRPC63PS	Center Pin and Screw replacement set	1	3.62
----------	--------------------------------------	---	-------------



CS24L



CS36T

HARVARD CONTRACTOR'S PVC Cable Saw

Features:

- Multi-purpose cable saw cuts PVC pipe.
- Available in two lengths and two handle styles



Part Number	Description	Ctn Qty	List Price
Cable Saws			
CS24L	Cable saw, 24" length, Loop handle	50/500	\$ 8.57
CS36L	Cable saw, 36" length, Loop handle	5/200	12.29
CS36T	Cable saw, 36" length, T handle	50	12.57



TBS300

14" PVC/ABS Tool Box Saw Features:

- 14" saw for use with PVC or ABS. Cuts wood, aluminum and drain pipe.
- Durable ABS handle.
- Tempered steel blade with 15 teeth, 16 points.
- Cuts in both directions.



PVCSW

PVC/ABS Saw Features:

- 12" or 18" saw blade lengths.
- Aluminum die cast handle for sure grip.
- Cuts large diameter PVC or ABS pipe.
- Cuts drywall, paneling, plywood or plaster board.
- Precision milled teeth for faster, cleaner cuts.
- Induction hardened teeth for longer life.
- Cuts in both directions.
- Quick change design allows for changing blades without tools.

Part Number	Description	Ctn Qty	List Price
TBS300	Tool Box Saw, 14" length, 15 teeth, 16 pt.	4/48	\$ 30.68
PVCSW12	PVC Saw, 12" aluminum handle	12	33.12
PVCSW18	PVC Saw, 18" aluminum handle	12	36.27
PVCSW12B	PVC Saw 12" BLADE ONLY	12	16.11
PVCSW18B	PVC Saw 18" BLADE ONLY	12	19.63



T22466

TASK HIGH TENSION HACKSAWS

Task Contractor's High Tension Hacksaw

Features:

- Aluminum handle and end piece.
- Square tube frame prevents frame twisting.
- Multiple tension adjustment setting.
- 3 blade positions for 90°, 45° and use as a minisaw.
- Extra blade storage in frame.
- Unconditional warranty.



Part Number	Description	Ctn Qty	List Price
T22466	Contractors Hacksaw	6	\$ 54.26

BOSS® line of adhesives, grouts and lubricants are specifically formulated for use with pools and whirlpool baths.

BOSS PRODUCTS



BOSS® 801 Neutral Cure Silicone Adhesive Features:

- A one part, low odor, non-corrosive, oxime cure adhesive and sealant.
- Provides excellent adhesion to ceramic tile, spa jets, skimmers, lighting fixtures, plumbing and fiber optic lighting.
- Adheres well to fiberglass, ABS, acrylic, PVC, wood and masonry.



BOSS® 802 Acetoxy Cure Silicone General Purpose Adhesive Features:

- A one part, acetoxy cure, adhesive/sealant.
- Performs well in jet sealing applications.
- Designed for many other pool and spa maintenance and repair needs.



BOSS® 804 Neutral Cure Silicone Ceramic Tile Grout Features:

- A one part, low odor, non-corrosive, oxime cure silicone grout.
- Spreads easily and provides ample tooling time.
- Excellent adhesion to all ceramic tiles.

BOSS® 820 Pool & Spa Silicone Lubricant Features:

- Water washout resistant and non-solidifying compound.
- Provides superb lubricant for rubber o-rings.
- Non-corrosive, silicone lubricant compound.



BOSS® 315 RTV 100% Silicone Sealant Features:

- 100% Silicone rubber clear adhesive/sealant.
- Paste-like one component material cures to a tough, rubbery solid when exposed to moisture in the air. Can be applied overhead or on walls without sagging.
- Adheres to clean metal, glass, wood, ceramic and painted or plastic surfaces.

BOSS® 370 HVAC/R Silicone Sealant Features:

- For sealing heating, ventilation or air conditioning duct work.
- A one part acetoxy cure adhesive/sealant.
- Adheres well clean metal, glass, wood, silicone resin, rubber, ceramics & plastics.



Part Number	Description	Ctn Qty	List Price
80100B	Silicone Adhesive Clear, 10.3 oz cart	12	\$ 31.65
80101B	Silicone Adhesive White, 10.3 oz cart	12	31.65
80200B	Silicone Adhesive Gen Purpose, Clear 10.3 oz. cart	12	22.77
80201B	Silicone Adhesive Gen Purpose, White 10.3 oz cart	12	22.77
80131B	Silicone Adhesive Grout, Clear 3 oz. tube	12	16.63
80401B	Silicone Ceramic Tile Grout, White 10.3 oz cart	12	38.37
82000B	Pool & Spa Lubricant Clear, 5.3 oz tube	12	33.53
31500B	RTV Silicone Seal CLR 10.0 oz tube	12	34.86
31580B	RTV Silicone Seal CLR 8 oz pressurized can	12	45.99
37000B	HVAC/R Silicone Sealant Clear cartridge	12	28.76
37001B	HVAC/R Silicone Sealant White cartridge	12	28.76
37003B	HVAC/R Silicone Sealant Aluminum cartridge	12	28.76

BOSS® Expanding Foam Sealant

BOSS®
PRODUCTS



BOSS® 333 Expanding Foam Sealant Features:

- Easy to use, multi-purpose urethane foam.
- Unlike ordinary sealants, it expands **three** times it's original volume.
- Adheres to all building materials except PTFE, silicone and polyethelene.
- Seals by expanding into gaps, cracks and crevices.
- Uses including insulating, sealing and filling gaps around pipes, plumbing fixtures, ductwork and foundations.
- UL classified.

DIRECTIONS FOR USE:

1. Shake can before and during use.
2. Surface must be clean and free of grease and oil.
3. Can must be held UPSIDE DOWN during application.
4. Insert straw into void and depress the trigger. The use of protective gloves is highly recommended.
5. Fill void 50% full to allow for expansion.
6. Uncured foam can be cleaned with acetone or paint thinner.
7. Cured foam can be trimmed, sanded, painted or stained. Foam MUST be painted or covered if application is exposed to UV light.



R19028
CAULKING AND SEALANTS
SURFACE BURNING CHARACTERISTICS
APPLIED TO INORGANIC REINFORCED
CEMENT BOARD*
FLAME SPREAD: 5
SMOKE DEVELOPED: 2038FN

* Tested as applied in three 3/4" beads 5" on center covering 12.5% of the exposed test sample area.

Part Number	Description	Ctn Qty	List Price
33316B *	Expanding Foam Sealant, 12 oz can w/ application tip	12	\$ 22.67

* SHIPPING NOTE: Ground shipping only. Can NOT be shipped via air.



AquaMend

AquaMend® Underwater Repair Epoxy

- Ideal for pool & spa repairs.
- Resin and hardener in same stick
- Hand kneadable.
- Unaffected by chlorinated or salt water.
- Sets in 25 minutes, cures in 1 hour.
- Dries off-white.
- Can be sanded and drilled.

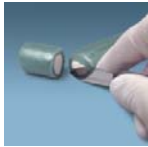

1. Cut



2. Mix



3. Apply

Part Number	Size	Display Ctn Qty	List Price
82093	7" stick	12	\$ 26.40



ISO 9001



3M Spray Adhesives

BLUE 72

- Repositionable BLUE pressure sensitive spray adhesive.
- One side bonds in 8 hours, aggressive tack, low soak in.
- Covers 100 sq ft.
- Ideal for pool liner installation.

ORANGE FOAM FAST 74

- Permanent, light orange, fast tack.
- Two sides bond in 15 minutes.
- Covers 260 sq. ft.

Both manufactured for AGI in an ISO 900 facility.

Pallet pricing available. Contact salesrep

Part Number	Size	Ctn/Pallet Qty	List Price
BLUE 72	Blue Spray Adhesive 24 fl oz can, 17.3 oz net wt.	12/768	\$ 59.80
ORANGE 74	Orange spray adhesive 24 fl oz can, 16.9 oz net wt	12/768	68.44



HDT Series

ISO 9002

POLYKEN®

Contractor/Industrial Grade Cloth Reinforced Duct Tape

- Multi-purpose duct tape.
- Polyethylene coated cloth backing.
- Natural rubber based adhesive.
- Temperature range: 40°F to 200°F
- Superior tensile strength, adhesion & tack.
- Recommended for pool liner installations.
- Conformable and will not curl or twist during application.
- 10 mil thickness
- Silver
- Manufactured for AGI in an ISO 9002 facility.

Part Number	Width x Length	Ctn Qty	List Price
HDT260	2" x 60 yards	24	\$ 34.66



FAL32



MARLIG INDUSTRIES, INC.

Fix A Leak Features:

- Fix A Leak is a blended material, designed to seal leaks in just about anything. It works in any kind of pool, spa or hot tub, regardless of constructed material, concrete, fiberglass, acrylic, wood, etc. It works equally well in all plumbing materials including PVC, ABS, poly plastics, vulcathen, copper, steel, etc.
- Seals leaks up to 1/8" in diameter.
 - Forms a permanent seal.
 - One quart is designed to seal leaks in up to 20,000 gallons. Do not use in excess of 1 quart per 5,000 gallons of water.
 - Cures in 24-48 hours.
 - Patented by Marlig Industries, Inc.

Part Number	Description	Ctn Qty	List Price
FAL32	Fix A Leak Sealant, 32 oz.	12	\$ 56.48
FAL8	Fix A Leak Sealant, 8 oz.	20	25.53

See the "Tapes, Sealants, Cements" and "Permatex Industrial" tabs for more installation & repair materials.

Installation & Repair



PTC163-6ST

PTC163-6RA

HARVARD CONTRACTOR'S Power Cord Features:

- Three prong straight (115V) or right angle (115V, 220V) molded plugs.
- 16 gauge, 3 conductor, 13 amp, 125 Volt rating.
- 14 gauge, 3 conductor, 15 amp, 250 Volt rating.
- Six foot cord length.
- Free end is split, stripped 3/8".
- SJTW Indoor/Outdoor rated.
- UL and CSA listed in US and Canada.



PTC143-6RA220

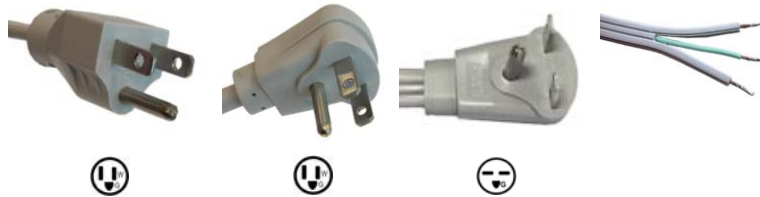

Part Number	Description	Wire Gauge	Volt Rating	Ctn Qty	List Price
PTC163-6ST	Straight plug cord	16	125 V	50	\$ 23.86
PTC163-6RA	Right angle plug cord	16	125 V	50	23.86
PTC143-6RA220	Right angle plug cord	14	250 V	50	38.84



HARVARD CONTRACTOR'S Anchor Kit Features:



- Anchor kits complete with 100 plastic anchors, 100 screws and 1/4" masonry drill bit in a plastic case.
- Plastic gray ribbed anchors with lip design for electronic timer, pump start relay installations. Use with concrete block, brick and wallboard.
- Anchors have internal ribs for better centering of screws, locking lugs against pull and twist. Exterior design prevents fall out in overhead holes.
- Kit available with combination slotted/phillips head or tri-combination, slotted/phillips/hex head #10 x 1" screws.
- Kits complete with 1/4" x 4" masonry drill bit.
- Clear, unbreakable plastic case with molded-in hanging tab.



Combo Head



Tri Combo Head



Part Number	Description	Ctn Qty	List Price
AK10CSPR	Ribbed Combo Head	36	\$ 24.55
AK10TCR	Ribbed Tri Combo Head	36	24.63



2136



LISTED

Swimming Pool,
Fountain and Spa
Equipment
Conductor Splice
Potting Compound
2L02

3M Scotchcast™ 2136 Wet-Niche Potting Kit Features:

- Provides protection against corrosion and deteriorating effects of pool water by encapsulating the 8 AWG ground connection in a wet niche shell.
- The wet-niche shell is a corrosion-resistant metal housing for underwater fixtures in permanently installed pools.
- Product meets NEC requirements to allow the use of rigid nonmetallic conduit in the installation of wet-niche underwater lighting fixtures.
- Packaged in easy-mix, single use, 1.5 oz. container with cleaning pad, application stick and gloves.
- Will not sag or drip. Gels in minutes and can be submerged within 4 hrs.

Part Number	Description	Ctn Qty	List Price
2136	Wet-Niche Potting Kit	10	\$ 194.20



10-417-15

Hot Water Swimming Pool Heater Safety Relief Valve Features:

- Bronze safety relief valve protects ASME Section IV hot water heating boilers and hydronic heating systems.
- High capacity design features corrosion resistant construction.
- Ideal for use in swimming pool heater applications, hot water boilers and hydronic heating systems.
- ASME Section IV.
- Set pressure 75 psi. 20-80 psig certified pressure range.
- Maximum temperature service 250°F
- Stainless steel springs.
- Registered in all Canadian provinces and territories, CRN #0G8547.5C
- Made in USA.

Part Number	Description	Height	Ctn Qty	List Price
10-417-15	3/4" M/F Safety relief valve	3"	100	\$ 103.76

Repair Fittings for Sch 40 Pipe



PEX Series



PIC Series

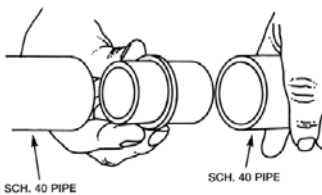
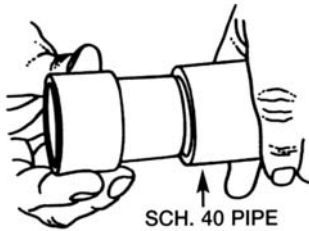

Pipe Extender and Inside Connector Repair Fitting

Features:

- For Sch 40 pipe.
- Saves labor.
- Invisible after installation.
- Permanent repair.
- Insignificant flow restriction.
- PVC Construction.
- PIC Series connects two pieces of Sch 40 pipe with flush joint.



Part Number	Description	IPS Size	Ctn Qty	List Price
-------------	-------------	----------	---------	------------

Pipe Extender Repair Fitting

PEX50	Pipe Extender	1/2"	48	\$ 3.32
PEX75	Pipe Extender	3/4"	48	4.32
PEX100	Pipe Extender	1"	48	5.49
PEX125	Pipe Extender	1 1/4"	48	6.42
PEX150	Pipe Extender	1 1/2"	48	7.57
PEX200	Pipe Extender	2"	48	8.57
PEX250	Pipe Extender	2 1/2"	96	11.63
PEX300	Pipe Extender	3"	96	16.81
PEX400	Pipe Extender	4"	48	19.64

Inside Connector Repair Fitting

PIC100	Inside Connector	1"	48	5.49
PIC150	Inside Connector	1 1/2"	48	7.57
PIC200	Inside Connector	2"	48	8.57



A simple squeeze to repair horizontal cracks and spalls, and to set anchors

DP600

Horizontal Concrete Repair Features:

Hardens in as little as 5 minutes,

Cracks and spalls in concrete floors are an eyesore as well as a potential safety risk. Fixing them has meant either hiring and waiting for an outside contractor or doing it yourself with a repair method that takes the floor out of service for up to 24 hours. Now with 3M Concrete Repair, you save money and time.

- Self-leveling urethane flows smoothly into cleaned cracks and gaps and hardens in as little as 5 minutes. A fork lift can pass over a repair in as few as 15 minutes.
- Hardens to any depth without cracking or shrinking.
- Flexible urethane expands and contracts for durability that outlasts repairs made with concrete.
- Do it yourself with a common caulking gun and eliminate the cost and wait for an outside contractor.
- *Easy to use - Just clean damaged area and fill. With every squeeze of the caulking gun trigger, cartridge nozzle meters and mixes precise proportions for optimum performance.*



Part Number	Description	Ctn Qty	List Price
DP600	Concrete Repair, 8.4 fl oz cartridge supplied with 2 nozzles	6	\$ 229.16



9" Ratchet Style Caulking Gun

Part Number	Size	Color	Ctn Qty	List Price
CG9	9" Ratchet	Blue	20	15.84



Horizontal Concrete Repair Specifications:

- Gray, self-leveling urethane concrete repair.
- 8.4 fl. oz. cartridge of concrete repair and 2 nozzles.
- Work life of 70 sec.
- Handling time of 5 minutes
- Cure time of 60 minutes

Applications:

- Repairing cracks and spalls on concrete floors or horizontal surfaces.
- Setting anchors in concrete floors or horizontal surfaces.
- Light-duty custom threading and anchoring.
- Use outdoors or in highly ventilated area.

Approximate coverage:

Crack Width	Crack Depth	Linear Feet per 8.4 fl. oz.
1/4"	1/4"	19.3
1/2"	1/4"	9.9
3/4"	1/4"	6.4
1"	1/4"	4.9
1/4"	1/2"	9.9
1/2"	1/2"	4.9
3/4"	1/2"	3.0
1"	1/2"	2.0

Bead Size dimension	Linear Feet per 8.4 fl. oz.
1/16"	815.0
1/8"	205.0
1/4"	51.9
3/8"	22.2
1/2"	12.4

Quick and Easy Spall Repair



Clean
Remove all loose material from area to be filled. Concrete should be dry and grease-free.



Fill
Dispense product into deepest part of repair areas, slightly overfilling. Product self-levels and is tack-free in as little as one minute.



Finish
In as little as 15 minutes, product can be sanded to remove rough edges. It can be painted within one hour.

Equipment Pads



The EcoPad™ Features:

- 98% recycled polypropylene plastic mounting pad.
- Environmentally friendly alternative to concrete due to recycled content.
- Designed to support HVAC outdoor units and other outdoor equipment like well equipment, pool pumps and filters.
- Optimized rib pattern provides excellent support on soil and gravel.
- Pad should be placed on level soil, gravel, concrete or asphalt.
- Textured top surface to reduce slippage.
- Drillable for securing equipment. (1/4x1 3/4" Tapcon® recommended)
- Unaffected by UV exposure or extreme weather.
- Black
- Tested per ASTM C67 and ASTM D2299

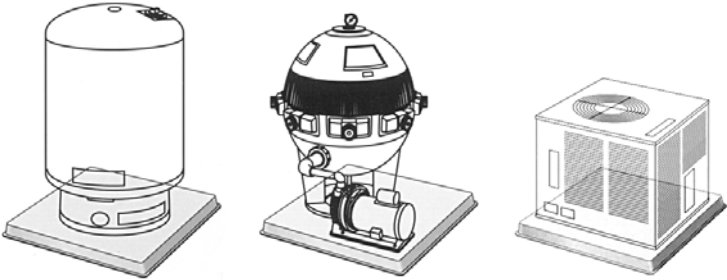

**NEW
STYLE**

Part Number	DISC Part Number *	Size	Pallet Qty	List Price
2" PADS				
EP2424-2		24" x 24" x 2"	44	\$ 101.94
EP3232-2		32" x 32" x 2"	22	164.29
EP3636-2		36" x 36" x 2"	22	201.08
EP3842-2		38" x 42" x 2"	16	250.03
3" PADS				
EP2424-3		24" x 24" x 3"	16	114.97
EP3030-3		30" x 30" x 3"	16	169.20
EP3232-3		32" x 32" x 3"	16	184.40
EP3636-3		36" x 36" x 3"	16	212.23
EP3648-3		36" X 48" X 3"	16	311.31

**CLOSEOUT
PRICING**

2" PADS - * DISCONTINUED - LIMITED QUANTITIES AVAILABLE				
	ACP38422	38" x 42" x 2"	24	260.59
3" PADS - * DISCONTINUED - LIMITED QUANTITIES AVAILABLE				
	ACP24243	24" x 24" x 3"	16	105.02
	ACP32323	32" x 32" x 3"	16	168.44
	ACP36363	36" x 36" x 3"	16	208.13
	ACP36483DT	36" X 48" X 3"	16	290.89

SPPW405

2 in 1 Swimming Pool Plug Wrench Features:

- Fits 1 1/2" or 2" cleanout plugs.
- 31" long.
- Removable 18" plated steel handle.
- Heavy duty, powder coated steel to resist rust and corrosion.
- No welds to corrode.

Part Number	Description	Ctn Qty	List Price
SPPW405	1 1/2" / 2" pool plug wrench with handle	24	\$ 72.02
SPPW405H	Replacement handle only for SPPW405	250	8.95

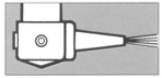
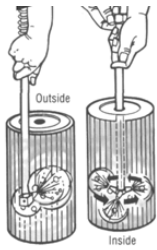
MBC75

Master Blaster Cleaner Features:

- 3/4" FGHT connection.
- Handy on/off lever.
- For general pool/spa cleanup of filters, under copings.

Part Number	Description	Size	Ctn Qty	List Price
MBC75	Master Blaster Cleaner	3/4"	12	\$ 23.57

AGLFB19

Ladder Bumper Features:

- White, molded EPDM.

Part Number	Description	Fits Tubes	Ctn Qty	List Price
AGLFB19	Male Ladder bumper	1.9" OD	200	\$ 9.57

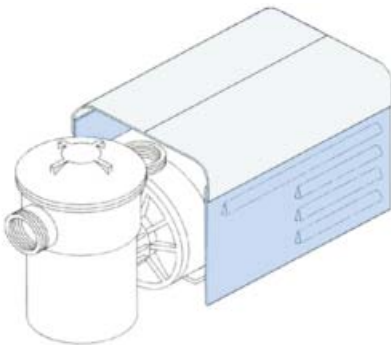
B8200C

Universal Motor Cover Features:

- Fits all motors from 1/3 hp to 2 hp.
- Shields and protects outdoor motors from sun, rain and dust.
- Made of heavy duty plastic for long life and durability.
- Heat resistant white top and attractive blue sides.
- Sturdy, will not fade from sun or ultraviolet rays.
- Assembles in minutes. No tools needed.

Part Number	Description	Ctn Qty	List Price
B8200C	Universal Motor Cover	12	\$ 55.95



Wingmaster® Plus Tool Features:

- The all in one **patented** tool for pool technicians.
- **Original** Wingmaster® Plus includes 7" cylinder, hexbar and hand knob.
- 5" Mini tool fits in tight spots such as main drains and skimmers.
- Nylon holster available separately.
- **US Patent #6,374,708**



MW, CWMP, RPNH

Typical Applications



Tighten/loosen winterizing and pressure testing plugs



Remove plugs from pipe using threaded end tool or adapter



Install/remove slotted plugs



Install/remove flush plugs



Raise/lower safety cover anchors (1/4" and 3/16" hex)



Hold plugs in place for vacuuming

Part Number	Description	Ctn Qty	List Price
CWMP	Wingmaster Plus Tool 7"	1	\$ 182.95
MW	Mini Wingmaster Plus Tool 5"	1	144.72
RPNH	Nylon Holster for CWMP/MW	1	45.71



Wingmaster® Anchor Extractor Features:

- Removes old cover anchors including anchors with escutcheons with the special design feature of the anchor extractor.
- **Anchor Extractor available only in NANSK or NANSK2 kit.**

To remove safety cover anchors:



1. Thread anchor with tap



2. Turn stud in anchor



3. Place extractor over stud



4. Thread castle nut onto extractor.



5. Attach tool. Turn clockwise to remove anchor.



6. Place square tip of stud into tool to remove old anchor from extractor.



Part Number	Description	Ctn Qty	List Price
JS	Hardened Stud (For 10-15 pulls)	1	\$ 39.37
CN	Castle Nut	1	48.98



KEMB

KEMB - Wingmaster® Castle Nut Driver Features:

- Tightens and loosens Castle Nut (CN) with use of cordless screw gun.
- Used in the removal of safety cover anchors with the NANSK Kit.
- Works with 5/16 Tap for the tapping (threading) of cover anchors.

Part Number	Description	Ctn Qty	List Price
KEMB	Castle Nut Driver	1	\$ 141.34



NANSE

Wingmaster® Shell Extractor Kit Features:

- Removes brass anchor shells - pop-up or threaded style.
- Includes SEW wrench, 11/16 tap and shell adapter.
- Wrench and tap available separately.
- **Shell Adapter available only with NANSE kit.**



1. Insert tap in pop-up shell to create threads (For threaded shell proceed to 2)



2. Thread adapter into shell



3. Thread stud in adapter 1/4"



4. Place tool on castle nut and turn clockwise to remove anchor

Part Number	Description	Ctn Qty	List Price
NANSE	Shell Extractor Kit	1	\$ 165.44
SEW	Shell Extractor Wrench	1	24.65
TAP1116	Tap 11/16	1	40.42

Wingmaster® is an American Granby Inc. registered trademark.

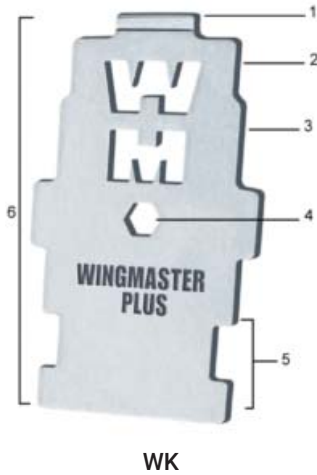

Wingmaster® Key Features:

Multipurpose, stainless steel service tool.

1. Screwdriver.
2. Install/remove 3-way Hayward valve unions.
3. Install/remove directional fittings.
4. Use hex bar through center hole for more turning and torque.
5. Install/remove universal wall fittings.
6. Install/remove Waterway Poly Jet series face ring.



1. Screwdriver to raise/lower slot-
ted anchors.



2. Install/remove
3-way Hayward
valve unions



3. Install/remove
directional wall fit-
tings



4-5. Install/remove
universal wall fit-
tings. Place hex bar
in hole for more turn-
ing and torque.



6. install /
remove
Waterway Poly
Jet series face
ring.

Part Number	Description	Ctn Qty	List Price
WK	Wing Key	1	\$ 57.62

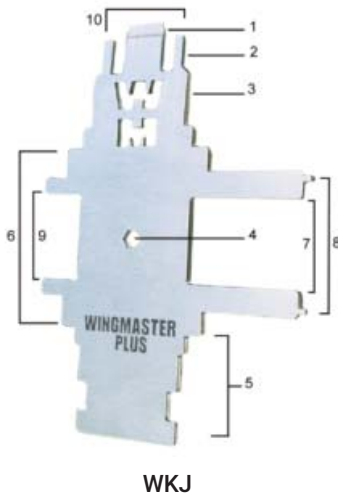

Wingmaster® Jet Key Features:

Multipurpose, stainless steel service tool.

1. Screwdriver.
2. Install/remove 3-way Hayward valve unions.
3. Install/remove directional fittings.
4. Use hex bar through center hole for more turning and torque.
5. Install/remove Polaris/Letro universal wall fittings.
6. Install/remove Waterway Poly Jet face rings.
- 7-8. Install/remove Hayward jet nozzle retaining rings or broken ring tips.
9. Install/remove Hydro-Air spa jet face ring.
10. Install/remove Hydro-Air (Slim-line) face ring.



7. Install/remove
Hayward jet noz-
zle retaining ring.



8. Install/remove broken
Hayward retaining ring
tips.



9. Install/remove
Hydro-Air spa jet
face ring



10. Install/remove
Hydro-Air Slimline
face ring.

Part Number	Description	Ctn Qty	List Price
WKJ	Jet Key	1	\$ 96.71

Wingmaster® is an American Granby Inc. registered trademark.



NANSK



Wingmaster® Plus Service Kit Features:

7" Multipurpose Wingmaster Plus tool, Anchor Extractor, Wing Key and carrying case.

Includes:

- Hand knob, cylinder, hex bar
- Anchor extractor, castle nut, hardened stud
- Anchor extractor for anchors with escutcheons (NANSK2 only).
- Wing key
- 12/24 tap
- 5/16 tap
- Molded Carrying case
- Wingmaster® Plus Tool. **US Patent # 6,374,708**

Part Number	Description	Ctn Qty	List Price
NANSK	Wingmaster Plus Service Kit	1	\$ 507.67
NANSK2*	Wingmaster Plus Service Kit	1	602.90
MHK	Hand Knob	1	40.03
MHB	Hex Bar	1	38.82
JS	Hardened Stud (For 10-15 pulls)	1	35.79
CN	Castle Nut	1	44.53
TAP1224	Tap 12-24	1	25.74
TAP516	Tap 5-16	1	25.07
BMC	Blow Molded Case	1	70.69

* Includes anchor extractor for removal of anchors with escutcheons.



KAAK



CTW

RSW

XPLUG

MW



SQW



SPW

Wingmaster® Plus Multipurpose Accessory Kit

Features:

Wrenches for multiple applications, packed in molded and padded case.

Includes:

- Caretaker Wrench
- Recessed Square Plug Wrench
- "X" Plug Wrench (JoSam)
- Square Plug Wrench
- Slotted Wrench for 1022 raised bar plug
- Mini Wingmaster® Plus Tool. **US Patent # 6,374,708**

Part Number	Description	Ctn Qty	List Price
KAAK	Multipurpose Accessory Kit	1	\$ 847.38
CTW	Caretaker Wrench	1	136.65
XPLUG	X Plug (JoSam)	1	117.84
SQW	Square Plug Wrench	1	110.06
SPW	Slotted Plug Wrench	1	125.80
MW	Mini Wingmaster Tool 5"	1	132.14

WB
Wingmaster® Bar Features:

- Raise or lower cover anchors from a standing position.
- Fits 1/4" and 3/16" anchors.
- Overall bar length is 32".



Part Number	Description	Ctn Qty	List Price
WB	Bar	1	\$ 51.77

OTWAB
Wingmaster® Wing Bit Features:

- Countersinks wood anchor flush to deck.
- Simple, fast and flush every time.
- Comes with 1 1/2" blade.
- 2" blade (Meyco) available.
- **US Patent # 7,264,427**



Part Number	Description	Ctn Qty	List Price
OTWAB	Wing Bit w/ 1 1/2" blade	1	\$ 459.37
OTRB1.5	Replacement Blade 1 1/2"	1	191.75
OTRB2	Replacement Blade 2"	1	142.40

HRVS
Wingmaster® Hydrostatic Tool Features:

- Install or remove hydrostatic relief valves in main drain or Sylvan "X" plug (JoSam) and floor return cap.



Remove/install Hayward hydrostatic relief valve in main drain



Install/remove Sylvan floor return cap and "X" plug (JoSam)



Part Number	Description	Ctn Qty	List Price
HRVS	Hydrostatic Tool	1	\$ 314.58

Wingmaster® is an American Granby Inc. registered trademark.



SCRT

Wingmaster® Easy Lift™ Spring Cover Removal Tool Features:

- Quick and easy installation and removal of cover springs with T-handle and quick spring grip.
- Stainless Steel T handle allows for greater leverage. Includes 1/4" and 3/16" stainless steel Allen wrenches to raise/lower anchors.
- 33" long steel bar.

Part Number	Description	Ctn Qty	List Price
SCRT	Spring Cover Removal Tool	1	\$ 203.51



LAW

Wingmaster® Anchor Socket Washer Features:

- Contoured washer to fit handrail and ladder anchor sockets.
- Fits up to 3/8" bolt.
- Insures a tight fit for safety.
- Allows bolt to have flush fit and wider coverage around anchor socket.
- Completes pool bonding.

Part Number	Description	Ctn Qty	List Price
LAW25	Anchor Socket Washers, 25 pack	1	\$ 210.37



WMSK

Wingmaster® Stencil Kit Includes:

- High quality stencils made of stainless steel.
- Numbers: 0,1,2,3,4,5,6,7,8,9, 1/2
- Letters for FEET, INCH, DEEP.
- NO DIVING symbol and words
- 2" high letters for FEET DEEP, INCHES DEEP.
- 3 top over spray panels.
- Molded storage case included.

Part Number	Description	Ctn Qty	List Price
WMSK4	Wing Stencil Kit, 4" high	1	\$ 694.80
WMSK5	Wing Stencil Kit, 5" high	1	1014.64



PDT

Wingmaster® is an American Granby Inc. registered trademark.

Wingmaster® Pipe Deburr Features:

- Removes PVC burrs from inside and outside of all size pipe.
- Cleans out pump impellers.
- Replacement blades available.



Part Number	Description	Ctn Qty	List Price
PDT	Pipe Deburr Tool	1	\$ 66.19
PDRB	Pipe Deburr Replacement Blade	1	11.91



MH

Wingmaster® Multi-Handle Features:

- Attaches to many pool maintenance tools to shorten poles for easier use in spas and tight spaces.
- Two holes to accept delcron spring clips.
- Plastic handle cover for sure grip.
- Use with skimmer nets, wall brushes and pumice stones.
- Use with 4" and 8" algae brushes for cleaning heat exchangers.

Part Number	Description	Ctn Qty	List Price
MH	Multi Handle	1	\$ 107.13



BC

Wingmaster® Burner Cleaner Features:

- Blow-through tube for hookup to compressed air.
- Textured (knurled) and curved end to grab spider webs.
- Easy access to accumulated debris in heater orifices.
- Works on Pentair, Zodiac and Hayward heaters.

Part Number	Description	Ctn Qty	List Price
BC	Burner Cleaner	1	\$ 58.70



DSSB

Wingmaster® Drain Screw Security Bit Features:

- Tighten and loosen uni-screw for drain safe lids.

Part Number	Description	Ctn Qty	List Price
DSSB	Drain Screw Security Bit	1	\$ 49.79



HWP Flush Plug



HWP Raised Plug



HWP Rubber Plug

Winterizing Plug Applications:

- Safely seals swimming pool inlets and outlets against freezing.
- Temporary pluggings of any water system application for either pipe or fitting sizes.

Plastic 1-1/2" Threaded Plug Features:

- Heavy duty, white ABS construction.
- EPDM o-ring is resistant to extreme weather & chemical corrosion.
- Gives a positive seal—no leaking.
- Available in raised or flush style.

Rubber Expansion Plug Features:

- Stainless steel screw and washers.
- Nylon wing nut provides easier turning in cold temperatures, providing greater tightness than conventional plugs.
- Tapered.

Part Number	D (in)	Plug Size	Used For	Case/Ctn Qty	List Price
-------------	--------	-----------	----------	--------------	------------

Plastic

HWP1022B(Flush)	1-1/2"	White	1 1/2" fip	1000/50	\$ 2.21
HWP1022C(Raised)	1-1/2"	White	1 1/2" fip	1000/50	2.40

Rubber

HWP2000	0.46	000	3/8" pipe	500/50	\$ 2.73
HWP200	0.63	0	1/2" pipe	500/50	3.76
HWP201	0.70	1	1/2" pipe	500/50	3.73
HWP202	0.75	2	3/4" tube	500/50	3.91
HWP203	0.89	3	3/4" pipe	500/50	4.09
HWP204	0.96	4	3/4" & 1" pipe	500/50	4.28
HWP205	1.02	5	1" tube	500/50	4.47
HWP2055	1.06	5 1/2	1" pipe	500/50	4.61
HWP206	1.20	6	1" fitting	500/50	4.75
HWP2065	1.27	6 1/2	1 1/4" pipe	200/20	5.17
HWP207	1.39	7	1 1/4" pipe	200/20	6.66
HWP2075	1.46	7 1/2	1 1/2" pipe	200/20	5.60
HWP208	1.54	8	1 1/2" pipe	200/20	6.78
HWP2085	1.62	8 1/2	1 1/2" pipe	200/20	6.12
HWP209	1.69	9	1 1/2" pipe & 1 1/4" ftg	200/20	7.61
HWP2095	1.73	9 1/2	1 1/2" fitting	200/20	7.94
HWP20975	1.81	9 3/4	1 1/2" fitting (for SP1023G)	200/20	6.58
HWP210	1.89	10	1 1/2" fitting	60/10	8.02
HWP211	2.13	11	2" pipe	60/10	10.77
HWP212	2.42	12	2" fitting	60/10	11.56
HWP213	2.58	13	2 1/2" pipe	30/5	19.33
HWP2135	2.82	13 1/2	3" pipe	40/5	16.92
HWP214	3.40	14	3" pipe	30/5	30.16
HWP215	3.86	15	4" pipe	30/5	29.39
HWP216	4.64	16	4" pipe	20/4	33.62
HWP1-5	1.02	01-05	Universal tapered 01-05	250/50	4.88
HWP5-7	1.36	05-07	Universal tapered 05-07	100/20	9.09
HWP7-10	1.78	07-10	Universal tapered 07-10	100/20	9.87

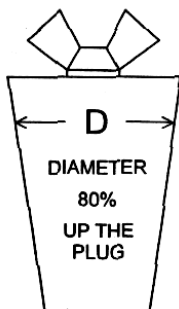
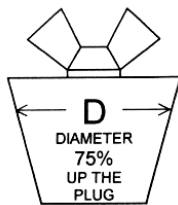

Winterizing Plugs

Extended Plug Features:

- Non-corrosive construction of heavy duty nylon wingnuts, stainless steel washers, spacers and high quality rubber.

Double Plug Features:

- Non-corrosive construction of heavy duty nylon wingnuts, stainless steel washers, spacers and high quality rubber with brass stem.

Blow Through Plug Features:

- Non-corrosive construction of heavy duty nylon wingnuts and caps, stainless steel washers, high quality rubber, extended brass air valve w/ spring loaded core.



HWP Extended Shaft



HWP Double Plug



HWP Blow Through



HWP Blow Through
Universal Tapered

Part Number	Plug Size	Case/Ctn Qty	List Price
Rubber Extended Shaft Plugs			
HWP202X	2	250/50	\$ 6.58
HWP203X	3	250/50	6.86
HWP204X	4	250/50	7.39
HWP205X	5	250/50	7.43
HWP206X	6	250/50	7.99
HWP207X	7	200/20	7.67
HWP208X	8	200/20	7.85
HWP209X	9	200/20	8.32
HWP210X	10	60/10	8.56

Double Plugs	top x bottom x spacing length x top spacer	Case/Ctn Qty	List Price
HWP98DP35	Anthony "L3" 09 x 08 x 3.5" x 2.3"	40/10	16.87

Blow-through Plugs			
HWP202BT	2	500/50	\$ 9.64
HWP203BT	3	500/50	11.23
HWP204BT	4	500/50	12.93
HWP205BT	5	500/50	14.58
HWP206BT	6	200/50	16.36
HWP207BT	7	200/20	17.39
HWP208BT	8	200/20	18.84
HWP209BT	9	200/20	24.68
HWP2095BT	9 1/2	60/10	21.07
HWP210BT	10	60/10	22.70
HWP211BT	11	60/10	23.32
HWP212BT	12	60/10	24.82

HWP1-5BT	Universal Tapered 01 - 05	250/50	15.42
HWP5-7BT	Universal Tapered 05 - 07	100/20	16.36
HWP7-10BT	Universal Tapered 07 - 10	100/20	32.87



SKG Series

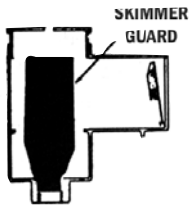

Winterizing accessories for pool closings



SKG Skimmer Guard Features:

- Installs in skimmer to prevent freezing and breakage.
- Ends are threaded for 1 1/2" and 2" applications.
- SKG-H with blowout hole, o-ring seals to allow skimmer lines to be blown out without dropping water level.
- SKG9H fits SP1090 series skimmers.
- SKG16H fits SP1070 and SP1080 series skimmers.

Water Tube and Air Pillow Features:

- Single and double tubes available.
- Double chambers extend life of water tubes.
- 12 and 20 mil thickness on tubes. 12 mil on pillows.
- Used for weighing down winter covers on inground pools.



DCWT Series



AP44

Part Number	Description	Color	Ctn Qty	List Price
Skimmer Guards				
SKG9	9" Skimmer guard	Teal-Green	36	\$ 8.21
SKG9H	9" Skimmer guard w/ blowout hole	Teal-Green	36	13.68
SKG16	16" Skimmer guard	Teal-Green	24	9.29
SKG16H	16" Skimmer guard w/ blowout hole	Teal-Green	24	15.67

Water Tubes				
SCWT8	8' Single chamber, 12 mil	Blue	36	8.47
SCWT8-20	8' Single chamber, 20 mil	Blue	24	12.11
SCWT10	10' Single chamber, 12 mil	Blue	30	10.39
DCWT8	8' Double chamber, 12 mil	Blue	36	9.07
DCWT10	10' Double chamber, 12 mil	Blue	30	10.89
DCWT8-20	8' Double chamber, 20 mil	Blue	24	12.61
DCWT10-20	10' Double chamber, 20 mil	Blue	24	14.82

Air Pillows				
AP44	4' x 5' Air pillow, 12 mil	Blue	24	13.47
AP48	4' x 8' Air pillow, 12 mil	Blue	12	22.89

Pool Cover & Utility Pumps



CCP300

Pool Cover Pump Features:

- Magnetic drive motor - Only one moving part.
- Completely submersible.
- Easily hooks up to any standard 3/4" garden hose.
- Extra-long 25' power cord with grounded plug.
- Sturdy ceramic shaft impeller.
- Includes easy clean clog resistant foam filter.
- 1 year warranty.
- Listed to UL and cUL standards.



CCP350 / CCP500

Part Number	Description	Max Output	Max Pump		List Price
			Height	Ctn Qty	
CCP300	Pool Cover Pump	300 gph	6'	18	\$ 151.59
CCP350	Pool Cover Pump	350 gph	7'	6	244.69
CCP500	Pool Cover Pump	500 gph	10.5'	6	252.46



91025 & 91330

Submersible Utility Pump Features:

- 1/5 & 1/3 HP motors, 120 v, 60 Hz
- Corrosion resistant construction.
- 10' waterproof power cord.
- Clog resistant open type impeller.
- Fits in 6" opening.
- Capacities of 26 & 40 gpm.
- 3 year limited warranty.



Specifications:

Discharge: 1 1/4" MNPT or 3/4" GHT
Housing & Base: Thermoplastic
Impeller: Thermoplastic
Bearing: Permanently lubricating
Motors: Permanent split capacitor, continuous duty, thermally protected



92250 & 92330

Submersible Sump Pump Features:

- 1/4 & 1/3 HP motors, 120 v, 60 Hz
- Corrosion resistant construction.
- 10' waterproof power cord.
- Clog resistant open type impeller.
- Switch turns on at 9", off at 4".
- Handles 1/8" solids.
- 3 year limited warranty.



Specifications:

Discharge: 1 1/4" MNPT
Housing & Base: Thermoplastic
Impeller: Thermoplastic
Bearing: Permanently lubricating
Motors: Permanent split capacitor, continuous duty, thermally protected

Model No.	HP	Gallons per minute at discharge height in feet						Min. Lift	Min. Amps	List Price
		0'	5'	10'	15'	20'	25'			
SP91025	1/5	26	21	14	10	7	1	25'	3.6	\$ 261.19
SP91330	1/3	40	34	28	22	12	2	25'	4.1	324.29
SP92250	1/4	30	22	20	16	9	2	25'	3.8	329.73
SP92330	1/3	40	34	28	22	12	2	25'	4.1	349.51

NOTE: Use of smaller diameter pipe, or long runs of pipe, will result in lower flow rates than those shown.